



# USER GUIDE



Original user instructions

# Safety First

IMPORTANT!

READ THESE INSTRUCTIONS AND SAFETY GUIDE CAREFULLY BEFORE USE. RETAIN FOR FUTURE REFERENCE

## ① Safe Operating Practices

## ② Symbol Definitions

## ③ Safety Features

### **Annex A – Battery removal instructions**

This product is an autonomous robotic mower, powered by a rechargeable lithium-ion battery and includes a base station.

The mower will independently depart from the base station, mow the lawn and return to the base station for charging.

A pre-installed perimeter wire connected to the base station sets the boundaries (a “virtual wall”) for the mower. It will be laid around the edges of the lawn and around objects that the mower should avoid.

The mower moves randomly within its working area, as defined by the perimeter wire.

The mower includes Bluetooth and GSM radio modules (on selected models).



Do not allow children to use or operate the mower. Children must be supervised at all times.

This guide includes the original manufacturer's instructions in terms of Directives 2006/42/EC and 2014/53/EU. It may describe models that are not available in your country.

Please note the terminology below when using this guide.

Front and rear of the mower:

The front is the opposite side to the (red) STOP button. It is the direction of travel of the mower and where the passive wheel/s are located.

The rear is where the (red) STOP button is located, and where the traction drive wheels are located.

Left and right directions are determined when standing at the rear of the mower and looking at its front.

## Safety Guidelines



### DANGER

Describes situations, where, if the hazard is not avoided, it will cause death or serious injury.



### WARNING

Describes situations, where, if the hazard is not avoided, it may result in death or serious injury.



### CAUTION

Describes situations, where, if the hazard is not avoided, it could result in minor or moderate injury, or damage to property and/or the product.



Provides information on proper use of the product and avoidance of possible operating malfunctions.

# Important Safety Information



## WARNING

It is your responsibility to:

- Restrict the use of this mower to persons who have read, understood and followed the warnings and instructions in this guide and in the mower.
- Inform your neighbours that you have a robot mower in operation and that they may be injured if they access your lawn during operation.



## DANGER

Always connect the power supply to the indoor, weather-protected power supply circuit protected by a residual current device (RCD) with a tripping current of not more than 30 mA. Follow local electrical installation instructions.



## WARNING

Allow the blades to stop rotating completely before lifting or tilting the mower or approaching the blades.



## DANGER

The power supply cord must not be replaced! If the cord is damaged, the entire power supply must be replaced. Do not connect a damaged power supply cord to the power supply and do not touch a damaged power supply cord as it can cause electric shock.

Keep all power supply cords away from underneath the mower to prevent damage.



## CAUTION

In case of lightning, disconnect the perimeter wire from the base station and unplug its power supply from the socket.

# **Safe Operating Practices**

## **A. General Information**

1. Read, understand and follow all instructions on the mower and in the manual(s) before attempting to assemble and operate. Keep this manual in a safe place for future and regular reference and for ordering replacement parts.
2. Familiarise yourself with all controls and their proper operation.
3. It is your responsibility to inform your neighbours that you have a robotic mower and the risk of injury if they access your lawn during its operation.
4. If your lawn is open to the street and/or your neighbour's property, you must be present during the mower's operation to prevent others from coming into contact with the mower during operation. Alternatively, you must fence your lawn so that others cannot access it during operation.
5. Never allow children under 14 years of age to operate the mower using the remote control app. Children aged 14 and over should read and understand the instructions for safe operating practices in this manual and on the mower and should be trained and supervised by an adult.
6. Never allow children, persons with reduced physical, sensory or mental capabilities or people who are unfamiliar with these instructions to operate the mower.
7. If situations occur which are not covered by this manual, use care and good judgment. Contact your customer service representative for assistance.
8. This mower is a precision piece of power equipment, not a toy. Exercise extreme caution at all times. This mower has been designed to perform one job: to mow grass. Do not use it for any other purpose.

## **B. Preparations Before Operating**



**PRIOR TO FIRST USE, ENSURE THAT PRODUCT HAS BEEN CHARGED CONTINUOUSLY FOR 24 HOURS.**

1. Ensure the correct installation of the perimeter wire, as instructed in the Getting Started Guide.
2. Thoroughly inspect the area where the mower is to be used. Remove all stones, sticks, wires, toys and other foreign objects which could damage the blade or be picked up and thrown by the blade. Thrown objects can cause serious personal injury.
3. Keep bystanders, children and pets inside while the mower is in operation. Stop the mower if anyone enters the mowing area.
4. If there is a risk of lightning, keep the mower in a protected area and disconnect it from the power supply.

# C. Operation



## WARNING

**Do not allow the mower to operate unattended if you know that there are, or may be, pets, children or people in the vicinity.**

1. Your robotic mower is a dangerous power tool. Exercise care when operating it and follow all safety instructions and warnings.
2. In the event of an accident or malfunction during operation, press the red STOP control immediately.
3. Do not operate the mower if any safety feature or any part is damaged, worn or inoperable.
4. Always turn the mower off by removing the disabling device before lifting the mower or clearing blockage of the blade(s) and/or drive wheels or making any adjustments. Activating the disabling device cuts power to the drive wheel and blade.
5. Never pick up or carry the mower while the wheels are turning or blade is moving. Do not touch the blade before it has stopped rotating completely.
6. Do not use the mower for any purpose other than cutting grass.
7. Never attempt to bypass a safety device or to remove a guard or cover. Doing so may result in personal injury through contact with the rotating blade. The sensors are safety devices.
8. The blade continues to rotate for up to two (2) seconds once a safety sensor has been triggered or the red STOP control has been pressed. Never place any part of the body in the blade area until you are certain that the blade has stopped rotating.
9. Should the mower start to vibrate abnormally, stop the motor and check for the cause immediately. Vibration is generally a warning of a problem. Pull out the disabling device to prevent any operation of the mower.
10. Always wear safety goggles during remote control operation and while performing an adjustment or repair to protect your eyes. Thrown objects which ricochet can cause serious injury to the eyes.
11. Never operate the mower with a damaged safety device, guard or cover. Failure to follow this warning may result in personal injury.
12. Do not put hands or feet near rotating parts or under the cutting deck. Contact with the blade(s) can cause amputation of the hands and feet.
13. Watch for holes, ruts, bumps, rocks or other hidden objects. Uneven terrain or hidden objects could cause an accident. Tall grass can hide obstacles.
14. Your mower is designed to cut normal residential grass of a height no more than 6" (15 cm). Do not attempt to mow through unusually tall grass (e.g. pasture).
15. Do not operate the mower without the cover door closed.
16. Set the weekly programme so that the mower is in operation when no one is likely to be on the grass. To schedule suitable operating hours, follow the one-time setup procedure on the mower's screen or via the mobile application.
17. Do not connect a damaged power supply cord to the power supply or touch a damaged power supply cord before it is disconnected from the power supply, as doing so can lead to electric shock.

18. Keep all power supply cords away from underneath the mower to prevent damage. A damaged power supply cord can lead to electric shock. Disconnect the mains plug from the socket if the cord is damaged or entangled.

DO NOT TOUCH THE CORD BEFORE DISCONNECTING THE SUPPLY.

If the power supply is installed outdoors, do not operate or disconnect it when the temperature falls below 0° C or rises above 40° C to avoid the risk of fire.

19. Steer the mower manually only when it is within your range of vision. Stay within 6 metres of the mower when you are operating it manually.
20. Do not overreach, keep balance at all times and always be sure of footing on slopes; always walk, never run while operating the machine.

## D. Children

1. To avoid tragic accidents, you should always ensure that there are no children on the lawn. Children are often attracted to the mower and mowing activity. They do not understand the dangers. Never assume that children will remain where you last saw them. Never assume that children will stay away from the mower while it is operating.
2. Keep bystanders, children and pets inside while the mower is in operation and under the watchful supervision of a responsible adult. Stop the mower if anyone enters the area.
3. Be alert and turn the mower off if a child or bystander enters the area.
4. Do not allow children to ride on the mower. It is not a toy.
5. Never allow children to play on the lawn while the mower is in operation. Teach your children that the mower is dangerous and that they must stay away from it.
6. Never allow children under 14 years of age to operate the mower using the remote control app. Children aged 14 and over should read and understand the instructions for safe operating practices in this manual and on the mower and should be trained and supervised by an adult.

## E. Transport

Before moving or transporting your mower, follow the steps below:

1. Press or pull the red STOP control to stop the mower.
2. You may use the remote control (via the mobile app) to drive your mower from one place to another.
3. If you elect to carry your mower:
  - Turn the mower off by pressing the "OFF" button located under the cover door on top of the mower. The red STOP control then becomes a carrying handle.
4. Always carry with the blades facing away from you. Be careful to avoid contact with the sharp edge of the blade when lifting or carrying the mower.

## F. Remote Operation

1. Refer to the separate operator's manual provided with the downloadable app. Follow all warnings and instructions provided.
2. Always operate the mower according to the app instructions while standing away from the mower.
3. Keep a safe distance between you and the mower when it is in operation. Always stop mower operation before approaching it for any reason.
4. Exercise extreme caution when the mower is moving towards you.
5. Operate the mower remotely only in daylight or in good artificial light, and avoid operating on wet grass.
6. Never operate the mower remotely in bare feet, sandals, slippery or lightweight (e.g. canvas) shoes. Always wear substantial footwear and long trousers; always make sure of your footing on slopes.

## G. Batteries

1. Use only genuine batteries provided by the manufacturer. Battery part numbers are specified in the "Additional Information" booklet.
2. Do not open, drop or damage the sealed battery pack. Do not use the battery if it exhibits visible defects or deformations, if it is broken or cracked.
3. **DO NOT ATTEMPT TO REPAIR OR MODIFY BATTERIES!** Repair attempts may result in severe personal injury due to explosion or electric shock. If a leak develops, released electrolytes are corrosive and toxic.
4. Do not attempt to remove or destroy any of the battery components.
5. The battery pack contains electrolytes. In the case of electrolyte leakage from the battery pack, take the following action:
  - Skin contact: Wash the contact areas off immediately with water and soap.
  - Eye contact: Flush the eyes with plenty of clean water for at least 15 minutes. Do not rub.
  - Seek medical assistance.
6. Do not dispose of the battery pack in a fire. The cell may explode.
7. The battery is intended to be charged when it is inside the mower and properly connected to the mower. Always use the power supply provided with the mower. Improper use may result in electric shock, overheating or fire.
8. Do not use the battery for any purpose other than powering the dedicated robotic lawnmower. Use of the battery to power any other product is extremely dangerous.
9. Observe proper disposal laws and regulations for batteries to protect the environment. Refer to the "Rechargeable Battery Disposal" section of this user guide for additional information.
10. When replacing the battery, be sure to insert the battery connector correctly. Reversing the battery polarity may cause damage to the battery and mower.



# H. Slope Operation

1. All slopes require extra caution. If you feel that the mower cannot maintain traction on a slope, the slope is too steep to mow. Wet grass will decrease traction and may cause the mower to slip and slide on the slope. Serious injury or property damage could result.
2. For your safety, measure any slope before using the mower on the sloped area. Use a slope measuring device before setting up the mowing zones or operating this mower on a sloped or hilly area. Smart phone applications can also be used to measure slopes. The mower may slide out of the mowing area if the slope at the edge of the lawn is greater than 11° (20%).
3. Do not mow on slopes greater than the following:
  - Inside the lawn - 24° (45%)
  - Edge of the lawn - 11° (20%)
4. Do not operate the mower under any conditions where traction or stability are in question. Always be sure of the mowing surface. A tip or overturn could cause serious personal injury or property damage.
5. Stay at least 4' (1.2 metres) from drop-offs, ditches, slopes or the edge of water to help ensure that the mower does not slide out of the mowing zone. You could damage the mower or cause serious injury.

# I. Maintenance and Special Instructions

1. Keep the mower in good working order. Replace worn, damaged or broken parts. Manufacturer part numbers of the batteries, blades and power supplies are specified in the "Additional Information" booklet.
2. To avoid serious injury, do not modify the mower in any way.
3. Mower blades are sharp. Wrap the blade or wear gloves and exercise extra caution when changing the blade.
4. Always switch off the mower and remove the disabling device before servicing or clearing blockage of the mowing blade(s) and/or drive wheels or inspecting the mower. Never attempt to service or adjust the mower while it is in operation. Before cleaning, repairing or inspecting, make certain the blade and all moving parts have stopped.
5. The blade should come to a complete stop within two (2) seconds of pressing the red STOP control. If you do not hear the blade stop within two (2) seconds, your mower must be serviced professionally by an authorised service dealer before being used again.
6. Never use a high-pressure power washer or hose to clean the mower. Water can damage components and the programmable controller. Use a damp cloth to wipe the display clean.
7. Visually inspect blade for damage (e.g. excessive wear, bent, cracked). Replace the blade with the original equipment manufacturer's (O.E.M.) blade only. Non-O.E.M. blades will not fit properly and could potentially be unsafe.
8. Use of spare parts which do not meet the original equipment specifications may lead to improper performance and compromise safety. It will also void your warranty.
9. After striking a foreign object, or getting stuck, stop the mower and pull out the disabling device. Thoroughly inspect the mower for damage. Repair the damage before replacing the disabling device, starting and operating.
10. For areas close to a children's play area, bodies of water, drop-offs or public roads, supplement the perimeter wire with a rigid (wood/stone) boundary edge at least 6" (15 cm) high, which will help to prevent the mower from exiting the mowing zone.

11. If your mower is installed and operated in an open garden or a public location, you must place warning signs around those mowing areas, showing the following: "Automatic Lawnmower! Keep away from the machine! Supervise children!"
12. Clean or replace safety and instruction labels, as necessary.

## **J. Winter Storage**

### **The Mower**

Fully charge the mower in its base station for a minimum of 24 hours. Turn the mower off. Clean the mower and store it in dry indoor conditions at an ambient temperature above 0°C.

### **Base Station**

There are no special winter storage instructions for the base station. It can be left on the lawn during the winter.

It is recommended that the power supply be disconnected from the mains during the winter.

### **Annual Service**











To keep your mower in good condition, it is recommended that you take it to a certified dealer for service before or after winter storage.

The annual service may vary between different service providers and will include all or some of the following: cleaning the mower's parts and mowing deck, checking for worn parts (such as blades, wheels and other moving parts) and replacing them if required, testing the mower's functions and safety components, checking the battery and uploading the latest software version, possibly including newly added features.

## **K. Product End of Use**

1. The mower and its accessories should be properly disposed of at the end of their useful life to prevent waste electrical and electronic equipment from ending up in landfill sites, and to protect and improve the quality of the environment. Check with your local waste facility or municipality regarding disposal laws. Many municipalities provide special waste collection sites for the disposal of batteries and electronic equipment.
2. Do not dispose of the battery pack or the mower in unsorted municipal/household waste.
3. Do not dispose of the battery pack in a fire.
4. Refer to local and statutory regulations for any special disposal or recycling laws and requirements. Refer to the end of the Quick Reference section for disposal instructions.
5. The mower must be disconnected from the base station when removing the battery.
6. The battery must be removed from the device before it is disposed of. Follow the battery removal instructions as described in Annex A.
7. The battery must be disposed of safely.

# 2 Symbol Definitions

Symbol	Description
	<b>WARNING — READ THE OPERATOR'S MANUAL(S)</b> Read, understand and follow all the safety rules and instructions in the manual(s) and on the mower before attempting to operate this mower. Failure to comply with this information may result in personal injury or death. Keep this manual in a safe location for future and regular reference.
	<b>GENERAL WARNING</b> Warns of hazards and risks.
	<b>DANGER — AVOID AMPUTATION INJURY</b> Do not put hands or feet near or under the cutting deck. Contact with the blade can cause amputation of the hands and feet.
	<b>WARNING — AVOID CRASH/BLADE INJURY. KEEP A SAFE DISTANCE FROM THE MACHINE WHEN OPERATING.</b> Do not mow when children or others are around. To help avoid contact with the blade or a thrown object injury keep others away from the mower while it is in operation. Keep bystanders, children and pets inside while the mower is in operation. Stop the mower if anyone enters the area.
	<b>WARNING — AVOID THROWN OBJECT INJURY</b> Keep bystanders at least 15' (5 metres) from the mower during operation. Remove all stones, sticks, wire, toys and other foreign objects which could be picked up and thrown by the blade(s). Do not operate the mower without the cover door or safety devices being in their proper place and operational.
	<b>WARNING — AVOID CRASH/BLADE INJURY</b> Do not allow children to ride on the mower. It is not a toy.
	<b>WARNING</b> Turn the mower off before attempting to service it.
	<b>WARNING</b> Remove the disabling device before working on or lifting the mower.
	<b>WARNING — USE ONLY THE ORIGINAL POWER SUPPLY</b> Do not alter the power supply connection! Use only the original power supply unit provided by the manufacturer, with the mower or as a spare part. The correct part number is indicated on the product, on this label. A non-original power supply may result in fire and damage to the base station and the mower.
	Never use a high-pressure power washer or hose to clean the mower. Water can damage components and the programmable controller. Use a damp cloth to wipe the display clean.
	<b>CORRECT HAND PLACEMENT</b> Correct hand placement and orientation of blades when lifting the mower.

# 3 Safety Features



## WARNING

Your mower is equipped with numerous in-built safety features. However, the mower remains a hazardous device with sharp blades, which can cause serious injury to anyone who comes into contact with it.

Being on the lawn while the mower is operational is strictly prohibited.

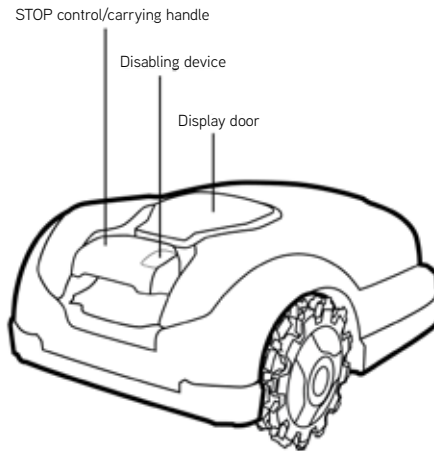

## A. Child Lock

The child lock prevents unintended operation of the mower by an accidental press of one of the buttons. Only pressing two buttons in the correct order will initiate operation. You must activate the child lock feature if children under the age of 6 may come in contact with the mower.

## **B. Anti-Theft Device (code-protected disabling device)**

The anti-theft device system function will prevent anyone from using or driving the mower unless they have a valid code to enter. You will be prompted to enter a four digit code of your choice to use as your personal security code. It is highly recommended that you activate this feature to prevent operation of the mower by children or people who are unfamiliar with the mower or not permitted to use it.

## **C. Lift Sensor**

If the mower is manually lifted off the ground, the mower and rotation of the blade will stop within two (2) seconds.

## **D. Tilt Sensor**

If the mower is tilted up towards a vertical position, the mower and rotation of the blade will stop within two (2) seconds.

## **E. Obstruction Sensor**

Your mower detects obstacles in its way during operation. If the mower collides with an obstacle, it will stop movement in that direction, reverse itself away from the obstacle and the mower and rotation of the blade will stop within two (2) seconds.

## **F. Stop Control**

Push or pull the red STOP control at any time during operation will stop the mower and the blade within two (2) seconds.

## **G. Removable Disabling Device**

Pulling out the disabling device will prevent any further operation of the mower. You must pull out the disabling device before lifting the mower and before any service work.

## **H. Base Station and Perimeter Wire**

The mower cannot operate without the perimeter wire and base station installed and activated. In the event that the perimeter wire signal is turned off, the mower will stop operating.

# Annex A – Battery removal instructions

---

1. Remove the disabling device.
2. Turn the mower off by pressing and holding the GO button for 2 seconds.
3. Insert the provided plastic key into the slot and rotate left by 90°, then pull the door halfway up until it stops.
4. Rotate the key backwards by 45° and pull the door up entirely.
5. Disconnect the battery from the mains.
6. Press the battery housing snap to remove the battery.

**Let's get  
started.  
Can't wait  
to mow your  
lawn.**



# Welcome to a friendly home

Congratulations on your purchase! You are just a few steps away from meeting your best team player. Very soon you will come to count on your new friend to do a perfect job.

It will automatically depart from its Base Station on predetermined days and times, mow your lawn and return to its Base Station for charging.

A pre-installed perimeter wire sets the boundaries (a “virtual wall”) for your mower. It will be laid around the edges of your lawn and objects that you want to protect.



The mower moves randomly within its working area, as defined by the perimeter wire. This kind of random movement provides the perfect cut and ensures complete coverage of your lawn.



In addition, it follows the perimeter wire when it mows the edges of your lawn to give it a perfect finish.

Good-looking healthy lawns are achieved by consistent mowing, which is exactly what your Robomow provides.

After following the installation instructions, you will be ready to enjoy your free time, while your new friend looks after your lawn.

It is highly recommended to read the complete installation guide prior to installation.

### **For easier installation**

It is recommended to mow the lawn with a traditional mower one last time and water the edges of the lawn 24 hours before installing the wire.

# What's in the Box

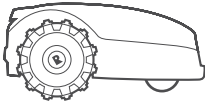

**The product**  
Your new Robotic Mower

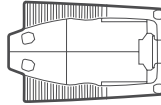

**Base Station**  
This is where the mower recharges itself

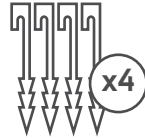

**Base Station Stakes**  
For affixing the Base Station to the ground

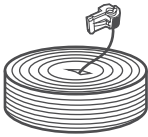

**Perimeter Wire\***  
Marks the working area for the mower  
*(\*) Not included in all models*



**Power Supply**  
The power supply for charging your mower



**Extension Cable**  
15 m (50 ft) low voltage cable to connect the base station to the power supply unit



**Wire Pegs\***  
For securing the wire to the ground  
*(\*) Not included in all models*

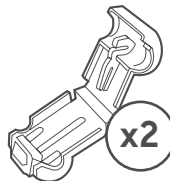

**Spare Plot Connector**  
For connecting the Perimeter Wire to the Base Station

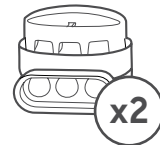

**Wire Connectors**  
For splicing the Perimeter Wire in case of a cut

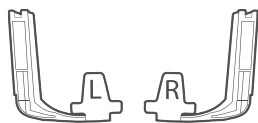

**Wheel cleaners**



**Safety guide  
Additional information  
Getting started guide**



**Wrenches for blade tip,  
blade disk, drive wheel**



**Plastic Battery Door Key**

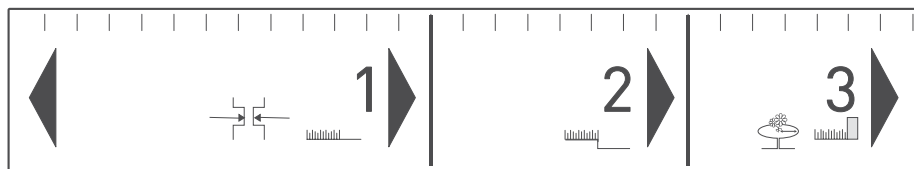

### **RoboRuler**

Required for setting the distance of the Perimeter Wire from the lawn's edge



**Additional tools required for installation**

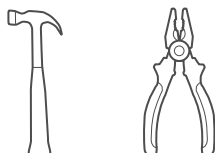

# **Ready? Let's begin...**

# So where are we heading?

Correct installation of your mower will ensure maximum results. This is what it takes to prepare it to do a perfect job for you:

## **1 Base Station location**

Choose Base Station location

1

2

## **Lay the wire**

Lay out the "virtual boundary"

## **3 Soft Obstacles**

How to protect soft obstacles

3

4

## **Hard Obstacles**

When should they be excluded

## **5 Slopes**

What slopes can the mower handle

5

6

## **Narrow pass**

How to wire a Sub-zone

## **7 Separated zone**

How to wire a separated zone

7

8

## **Finish**

Complete the installation



[www.robomow.com/goto/rk\\_installation\\_video](http://www.robomow.com/goto/rk_installation_video)

# Know Your Lawn

---

Understanding your lawn will save you unnecessary mistakes and make the installation process easier and more straight-forward.

Throughout this manual, skip sections which are not applicable to your lawn type.

So, what does your lawn look like?

## Type A

### Main Zone only

Your lawn area is one continuous zone and all areas of the lawn are wide enough for the mower to navigate through (at least 4 m (14 ft) wide at its narrowest point).

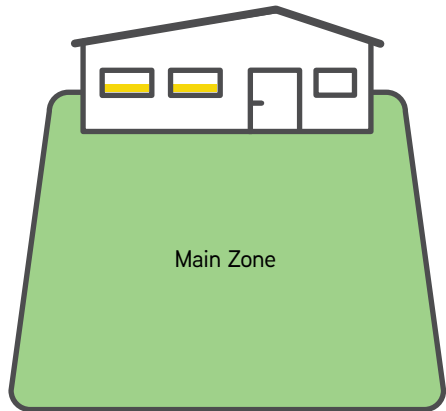

## Type B

### Main Zone + Sub Zone

Your lawn consists of more than one zone. These zones are connected by a narrow passage 1-2 m (3-6 ft). The mower can drive between these zones to mow the entire area.

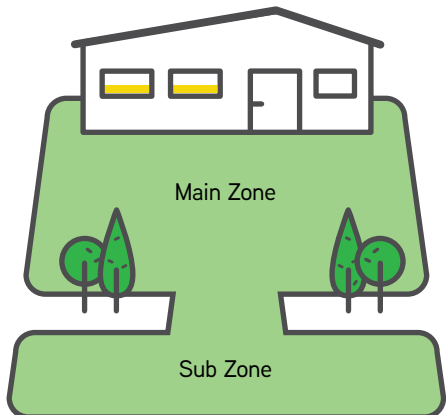

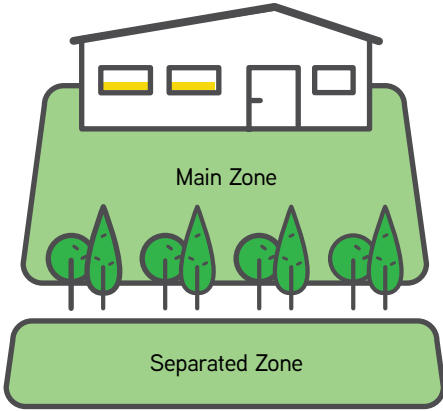

## Type C

### Main Zone + Separated Zone

Your lawn consists of two or more zones that are not connected (separated by a fence, sidewalk, pathway or other obstacle). The mower cannot drive between these zones.

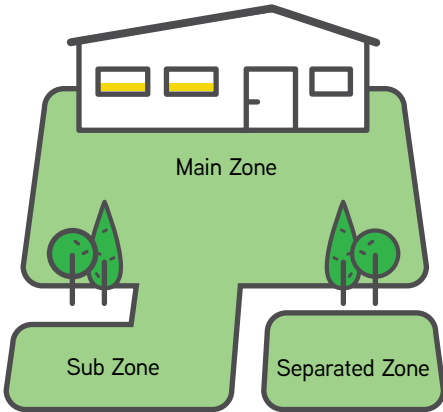

## Type D

### Main Zone + Sub Zone + Separated Zone

Some areas of your lawn are connected to the Main Zone by a narrow pass (up to 1-2 m (3-6 ft wide) and some areas are totally separated from the Main Zone by a fence, sidewalk, pathway or other obstacle, and the mower can't drive between them.

# 1 Base Station Location

Choose locations for the Base Station & Power Supply unit

The Base Station is where your mower recharges and where the perimeter wire starts and ends. In this installation step, you are going to determine a proper location for the Base Station.

## Where should you place your Base Station?

### Consideration A

It is strongly recommended to place the Base Station in the Main (largest) zone of your lawn

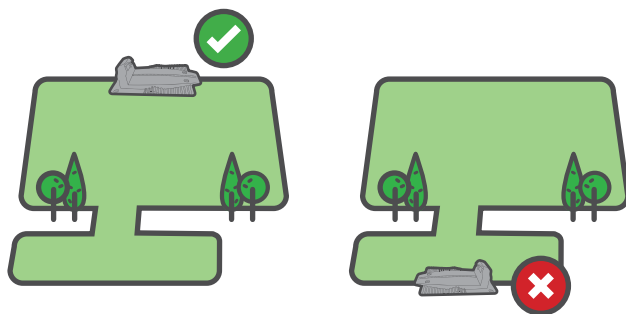

### Consideration B

Up to a max. of 15 m (50 ft) from a power outlet

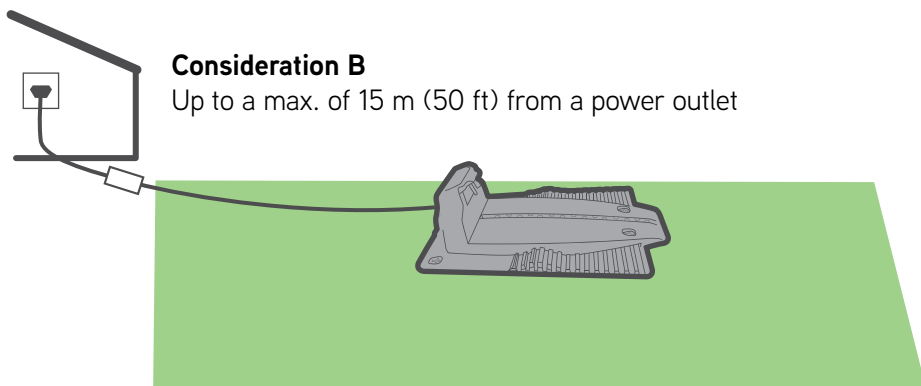

**Consideration C**

A minimum of 3 m (10 ft) of straight wire in front of the Base Station and a min. of 1 m (3 ft) behind the Base Station to allow smooth docking

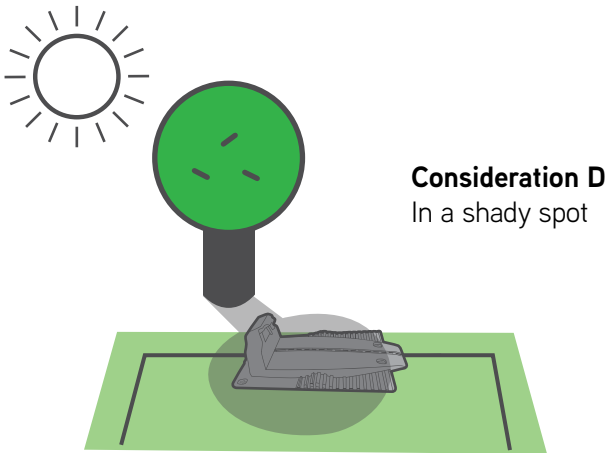
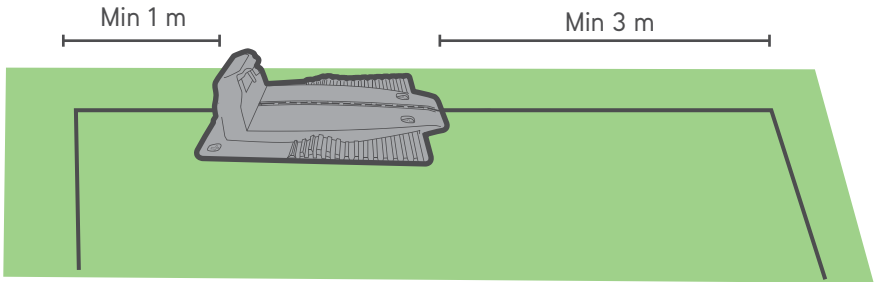

Keep a minimum of 1 meter (3.3 ft) from a sprinkler head to avoid damaging the mower's internal components

**TIP**



### Consideration E

Make sure the ground is even and flat, and that there is no slope



## How to install the Base Station?

### ORIENTATION

Place the Base Station according to the image below

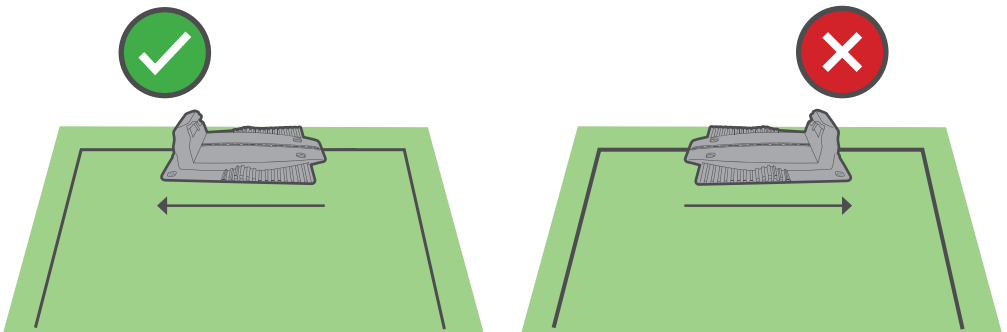

## DISTANCE FROM EDGE

Use the ruler to install the wire in the correct distance from the edge of your lawn.

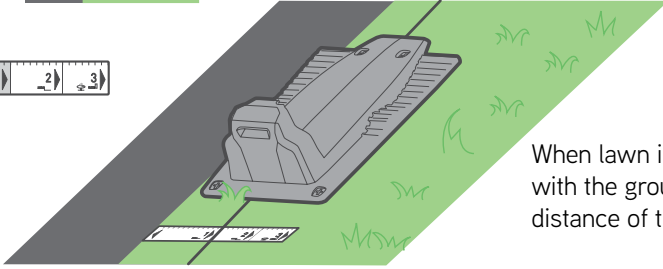

When lawn is level with the ground use 1st distance of the ruler

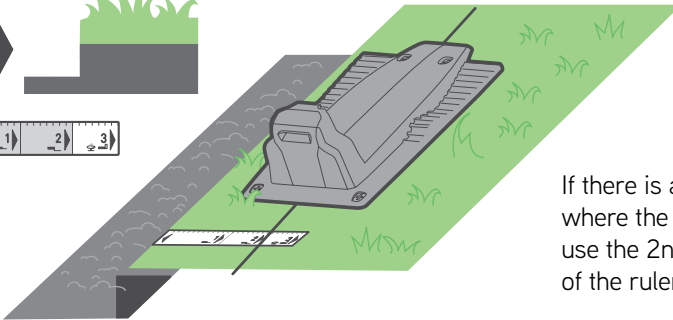

If there is a drop where the lawn ends use the 2nd distance of the ruler

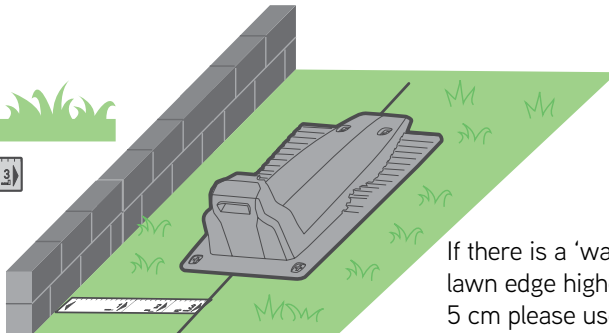

If there is a 'wall' on the lawn edge higher than 5 cm please use the 3rd distance of the ruler

## PEG BASE

After choosing the proper location, secure the Base Station to the ground using the provided stakes.

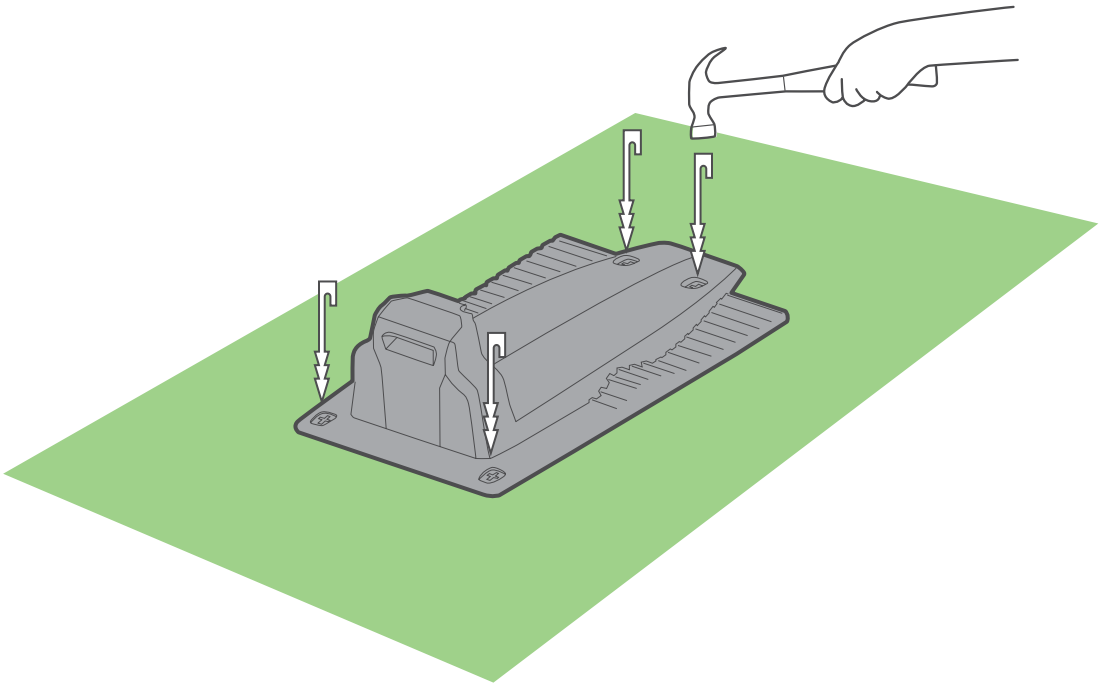

Be careful not to damage irrigation pipes when hammering down the stakes.



# Plan Ahead

Before you begin, walk along the edge of your lawn and plan how to set up the Perimeter Wire. Take note of all obstacles and slopes.



# Obstacles and Slopes

Before you put a single peg into the ground, take note of any obstacles or slopes.

## OBSTACLES



### Soft Obstacles

Soft obstacles are flower beds, ponds or small trees. They need to be protected by creating Perimeter Islands.



### Hard Obstacles

Hard obstacles are vertical, rigid and higher than 15 cm (6 in), such as trees or large hard elements that the mower can gently bump into without causing damage. There is no need to protect these obstacles with the perimeter wire.

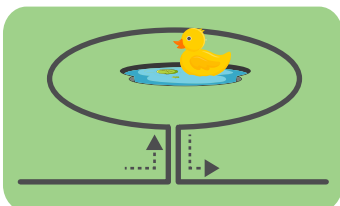

### Ponds

Ponds and other bodies of water need to be protected by creating Perimeter Islands.

## SLOPES

### Slopes along the edge

To ensure your mower doesn't slip off the lawn, especially when the grass is wet, the Perimeter Wire must exclude a slope along the edge of your lawn with an incline of over 20% - that is, 20 cm rise per 1 m [8 in rise per 3 ft].

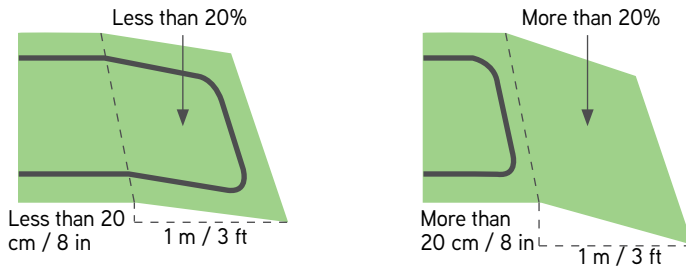

### Slopes within the Lawn

Your mower can mow areas within the lawn with a slope of up to 45%. You can include slopes near the edge if the slope is down towards the inside of the lawn, hence there is no risk for your mower to slip outside the lawn. A 45% slope means 45 cm rise per 1 m (17 in rise per 3 ft).

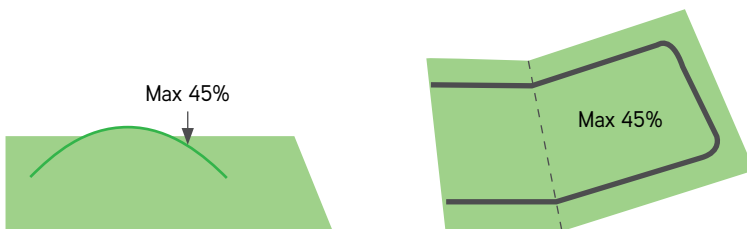

---

### The slope is too steep if...

The mower tilts off the ground while climbing it. Exclude such slopes from the cutting area.



**TIP**

# 2 Lay the Wire

---

Lay the perimeter wire (“virtual boundary”), which defines the working area for the mower.

Now you’re ready to install the Perimeter Wire. Let’s take it step by step.

---



## TIPS

- Have your mower’s package nearby.
  - Be sure to cut your grass with your old mower one last time before you start wiring. In addition, the ground should be moist. This will make inserting pegs easier and help ensure that the mower doesn’t cut the wire.
- 



## WHAT YOU’LL NEED

- Hammer
- Combination pliers



... A sunny day and a sunny mood :)

---

## Let's make a good start

Pull out approx. 50 cm (1.6 ft) of wire and peg the beginning of the wire to the ground where you intend to install your Base Station.

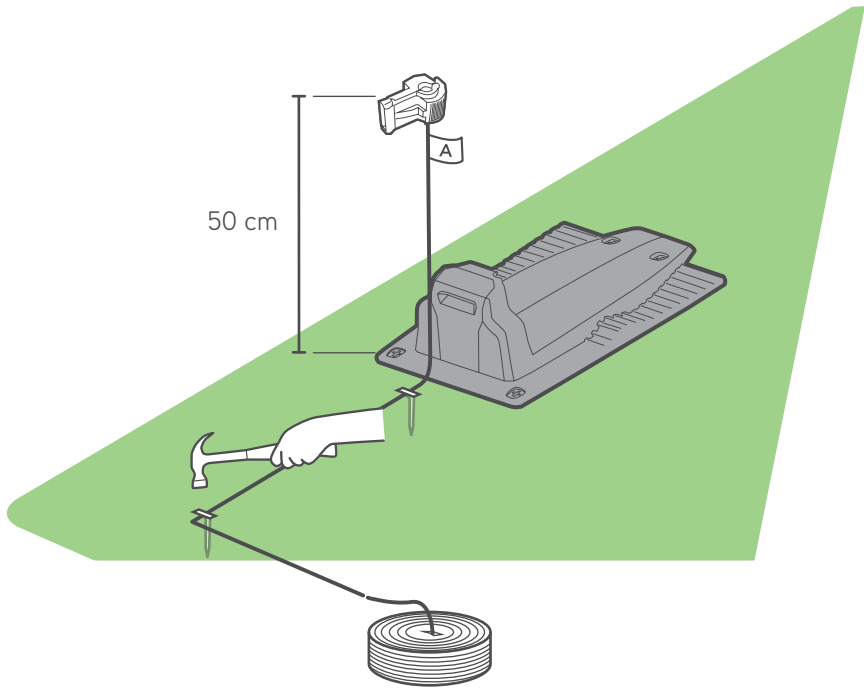

Start unwinding the wire counter-clockwise around the lawn, starting at the Base Station's location.

Lay it loosely along the perimeter as you walk along the lawn edge. If you get to any area/object that needs special care, make sure you carefully lay the Perimeter Wire as described in the following sections.



## Maintain Proper Distance

The Perimeter Wire is secured to the ground by the pegs supplied with the product. Use the RoboRuler to determine the distances you should leave between the Perimeter Wire and the lawn's edge and obstacles.

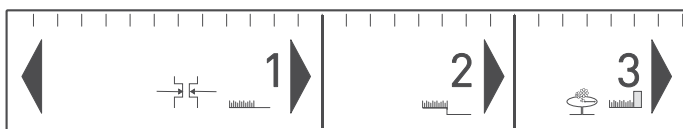
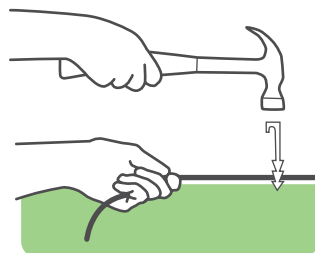

- Insert pegs every 2-3 m/7-10 ft and at corners. At this early stage, set a minimal number of pegs. You will insert all necessary pegs later.
- Pull the wire tight while hammering the pegs to their final depth in the ground.
- Take care not to damage irrigation pipes.

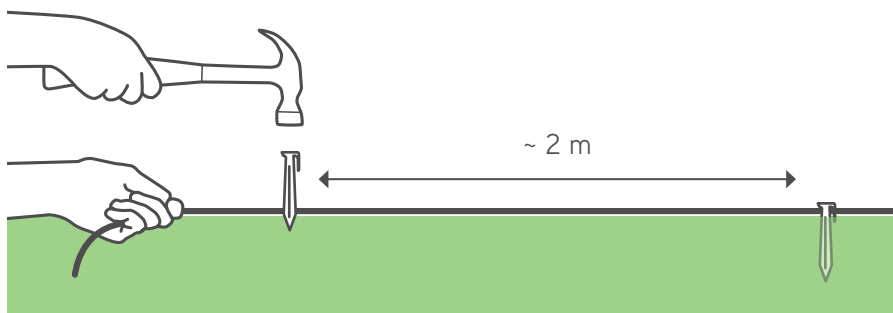

When the edge is flat, use the short distance of the RoboRuler.

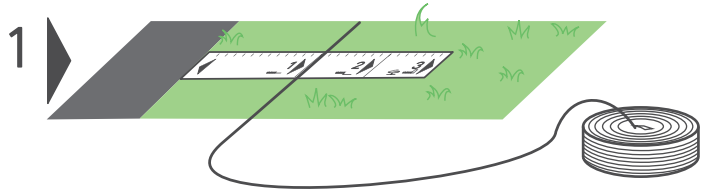

When the edge is a drop, use distance 2 of the ruler.

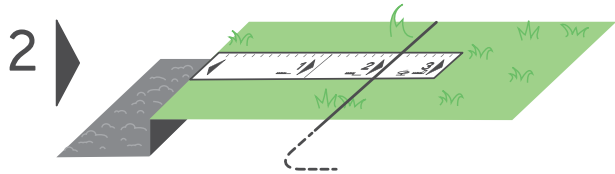

When the edge is a wall (more than 2 cm/ 1" above the ground level), use the 3rd distance of the RoboRuler.

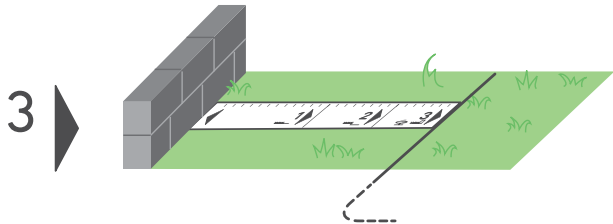

Leave a minimum of 1.2 m (4 ft) if the edge of the lawn borders water.

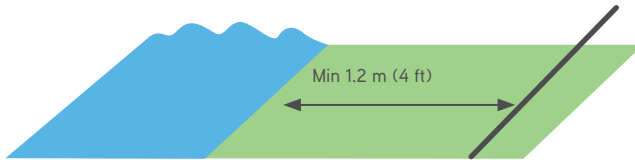

Alternatively, place a physical barrier close to the water.

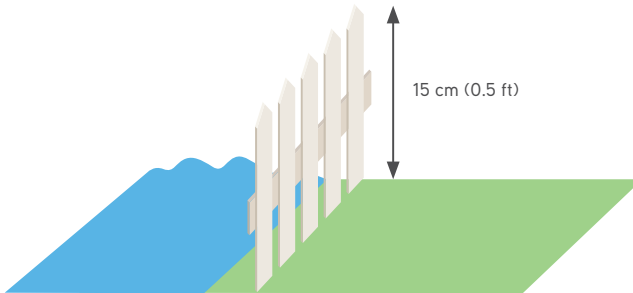

**TIPS**

- It is not necessary to bury the Perimeter Wire.
  - Burying the wire along exposed areas, such as pavements, is usually recommended.
  - If additional Perimeter Wire is required in order to complete the setup, you can extend it using the waterproof Wire Connectors provided (see page 43 “Splicing the Perimeter Wire”).
-

# 3 Soft Obstacles

## Protect Soft Obstacles

Objects such as flower beds, ponds, or small trees must be protected by setting Perimeter Islands.

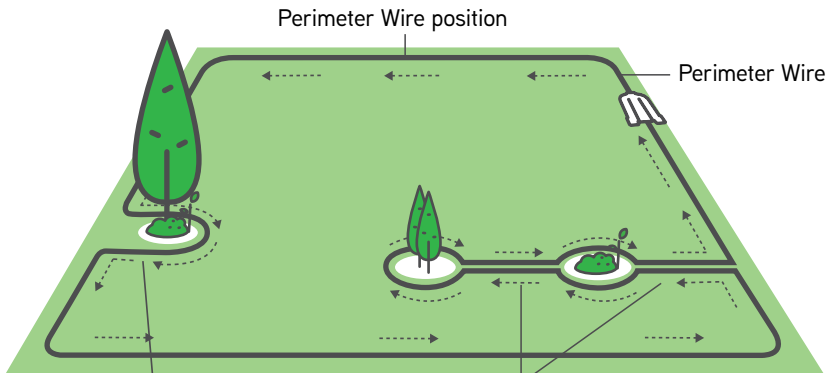

If the distance between an island and the perimeter wire is lower than 1.2 m (4 ft), make the obstacle part of lawn's edge.

Keep min. 1.2 m (4 ft) between islands; if obstacles are closer together, use one island.

Set the Perimeter Wire clockwise around the obstacle, otherwise the mower will drive into the Perimeter Island or won't be able to mow the area around it properly.

The two diagrams show a lawn with a tree island. The left diagram shows the perimeter wire set clockwise around the island, marked with a green checkmark. The right diagram shows the wire set counter-clockwise, marked with a red X. A warning icon is also present.

- Wires leading to and from an island should be fastened with the same peg



TIP

# 4 Hard Obstacles

## Protect Hard Obstacles

Exclude from the lawn any hard objects that are lower than 15 cm. Hard objects higher than 15 cm can be left unprotected inside the lawn.

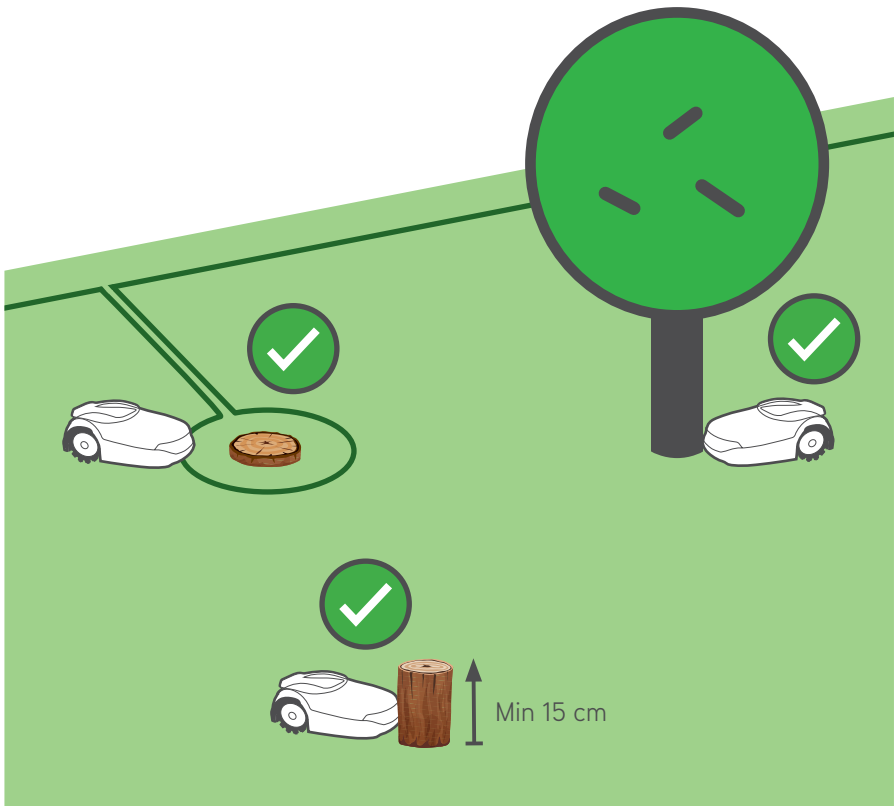

# 5 Slopes

## Slopes

Your mower can handle any slope up to 45% inside the lawn

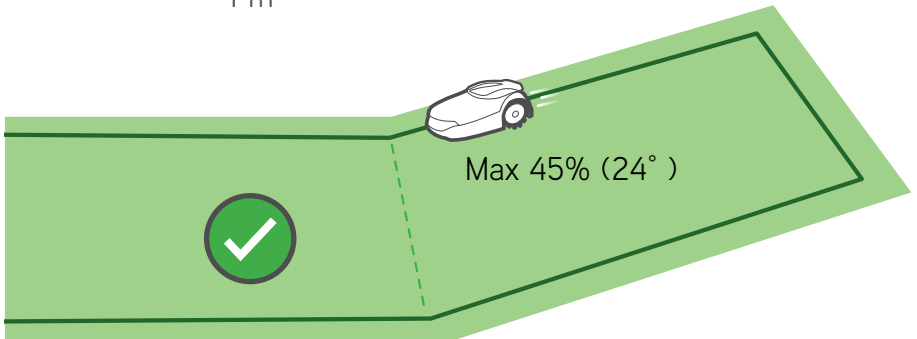
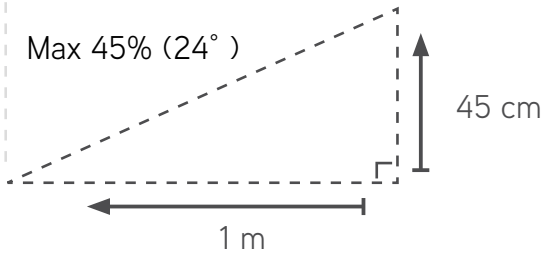
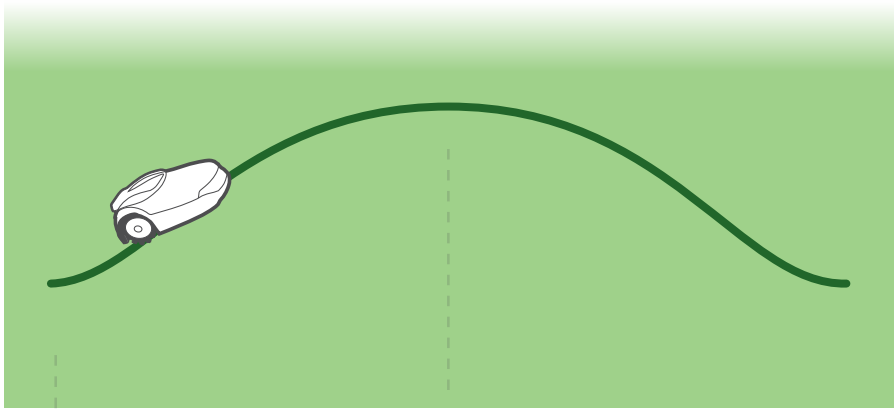

Exclude any slope greater than 20% that are on the edge of your lawn to prevent the mower from slipping outside your lawn (especially in wet conditions)

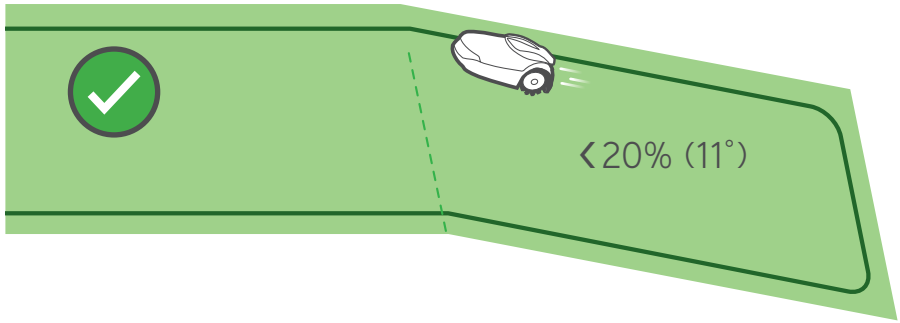

20% =

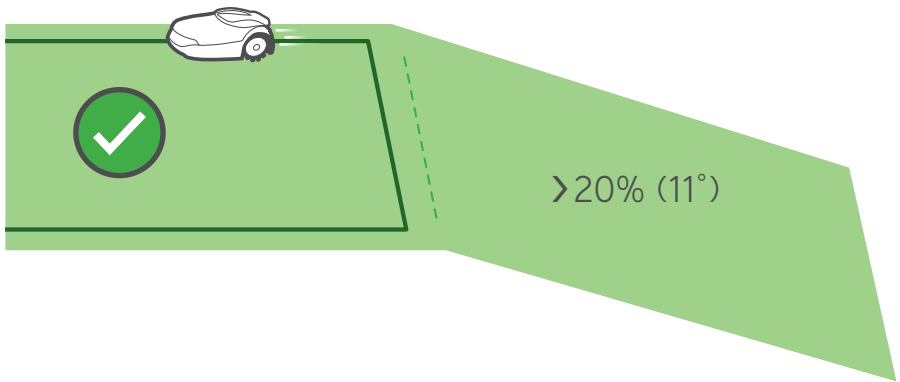
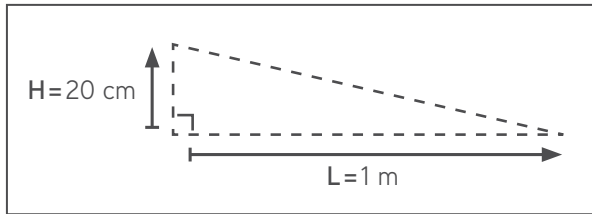

# 6 Narrow Pass

## Recall Your Lawn Type

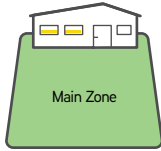

**Type A**  
Main Zone only

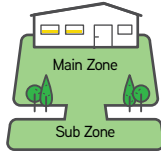

**Type B**  
Main Zone +  
Sub Zone

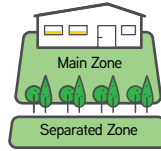

**Type C**  
Main Zone +  
Separated Zone

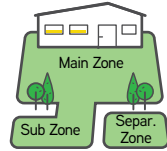

**Type D**  
Main Zone +  
Sub Zone +  
Separated Zone

## How to Wire a Sub Zone

Type B / Type D

Don't have a Sub Zone?  
Skip this section!

A Narrow Pass connects the Main Zone with a Sub Zone.

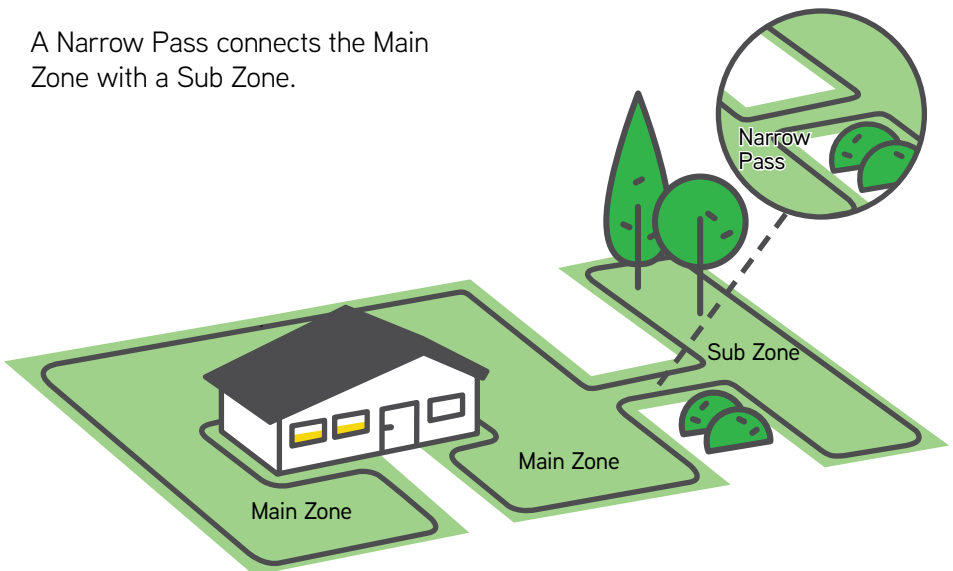



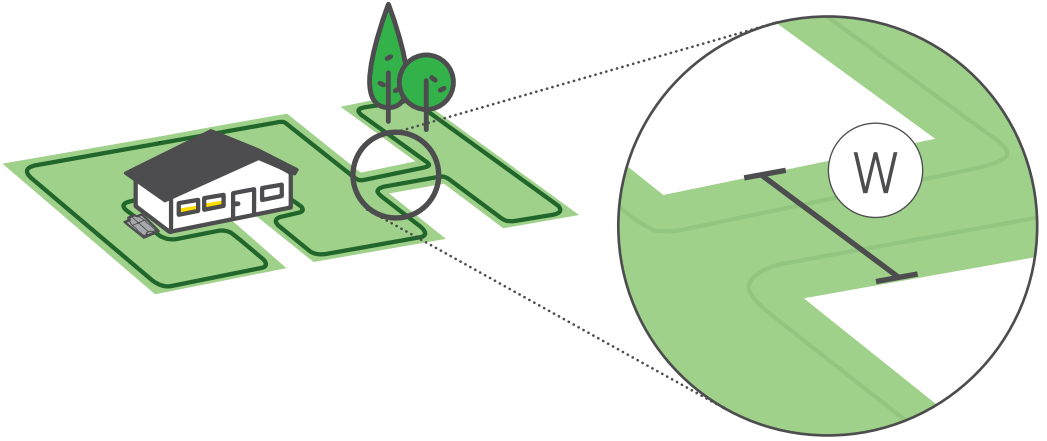

A Narrow Pass connects the Main Zone with a Sub Zone.  
For passages greater than 2 m (6.5 ft), the mower will be able to drive through.

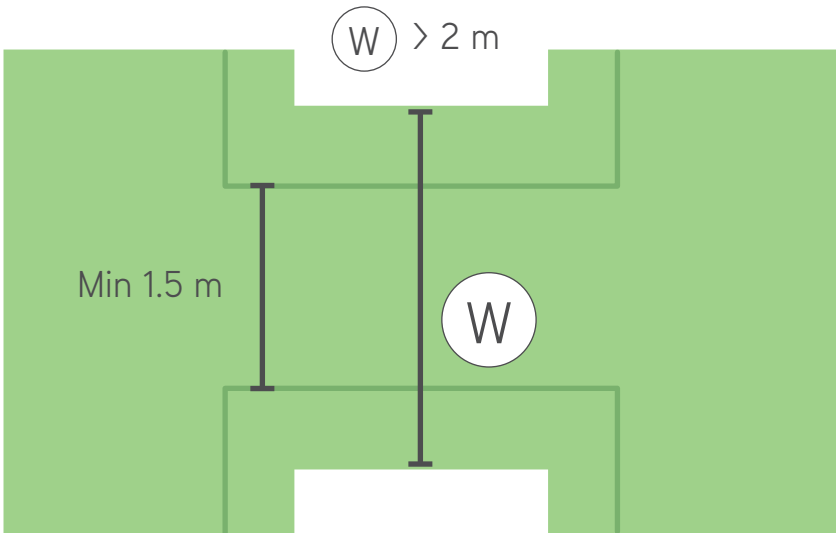

When a narrow pass is between 1-2 m (3-6 ft), the wires should be installed in the middle of the path with RoboRuler distance 1 between them to allow the mower to be able to follow the wires in and out of the sub zone. On the entrance to the path from both directions, you should break the corner to 45 degrees so the mower will turn accurately in and out of the narrow pass.

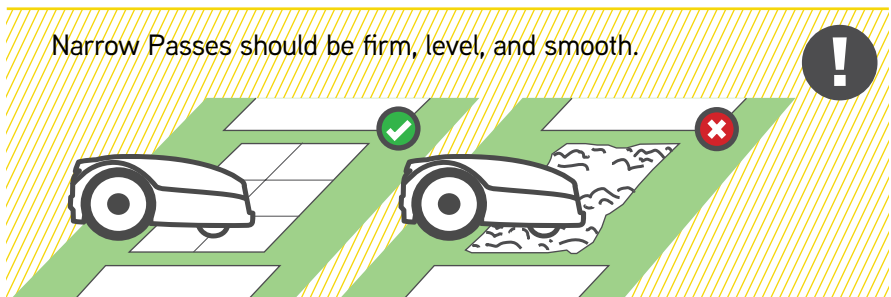
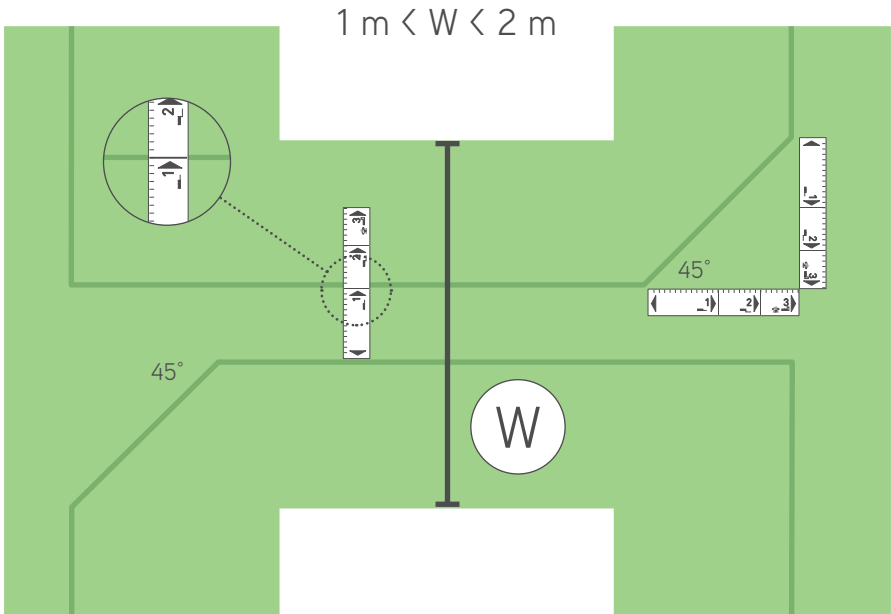

# 7 Separated Zone

## How to Wire a Separated Zone

Type C / Type D

Don't have a Separated Zone?  
Skip this section!

Extend the Perimeter Wire from the Main Zone, over the obstacle.

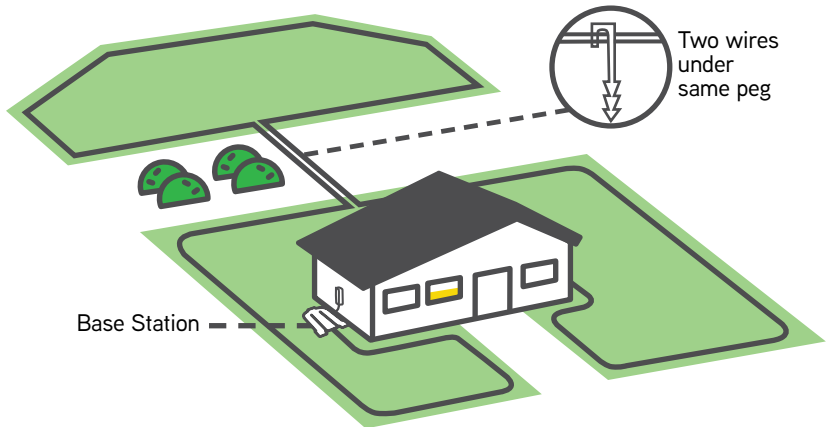



## TIPS

# Splicing the Perimeter Wire (as needed)

- Insert both wire ends into the leftmost and rightmost positions on the connector.
- Verify that the wires are fully inserted into the connector.
- Use a pair of pliers to press the button on top of the connector. The button should be fully pressed, without damaging the connector.

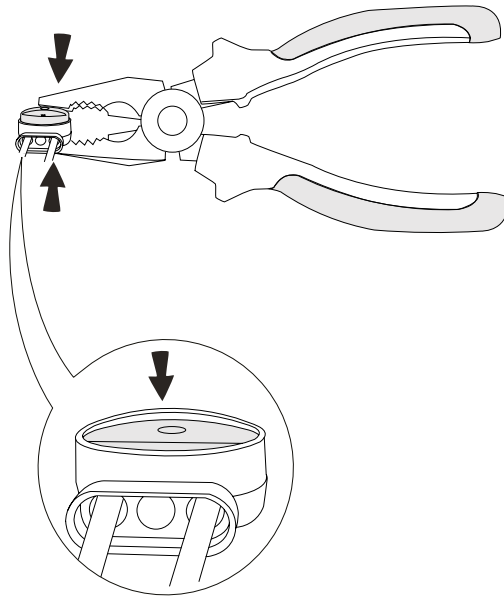
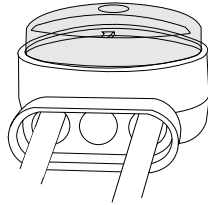

# 8

## Complete the installation

### Complete Wire Setup

Once the Perimeter Wire has been laid completely and you are back to the Base Station, install the last peg approx. 5 cm (2 in) in front of the base. It is very important that the wire will be in-line with the center of the Base Station.

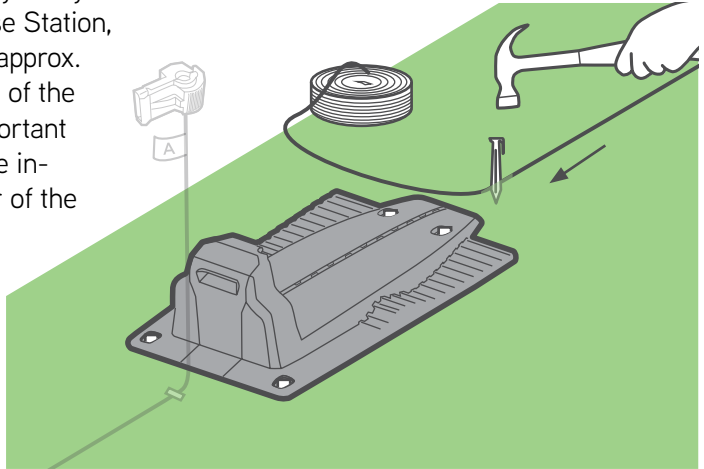

**TIP**

Unwind the wire up to about 50 cm beyond the Base Station and cut it.

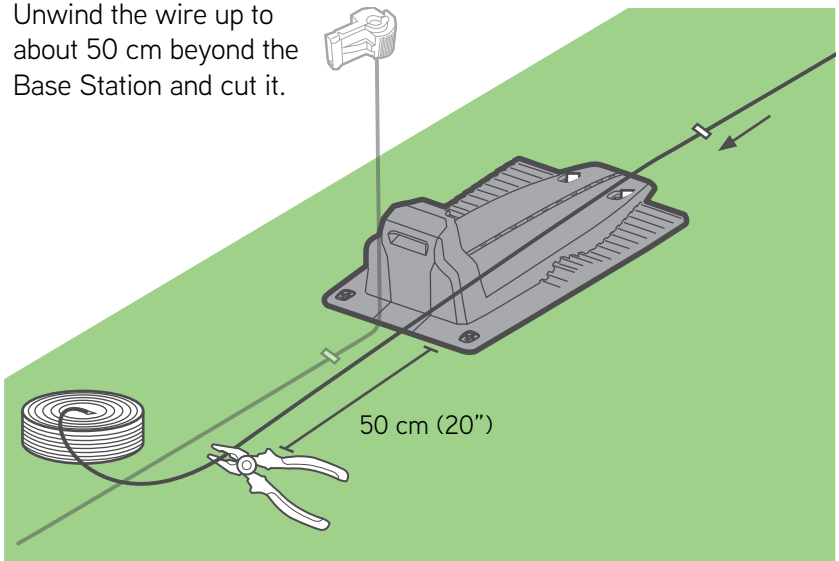

Open the back door of the Base Station.

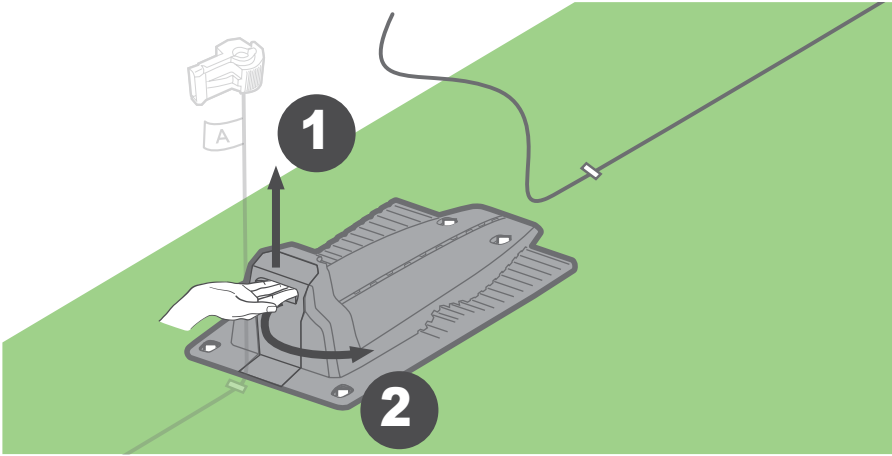

Slide or install the wire through the designated tunnel and pass it through the opening under the charging connectors until it goes out to the back of the Base Station.

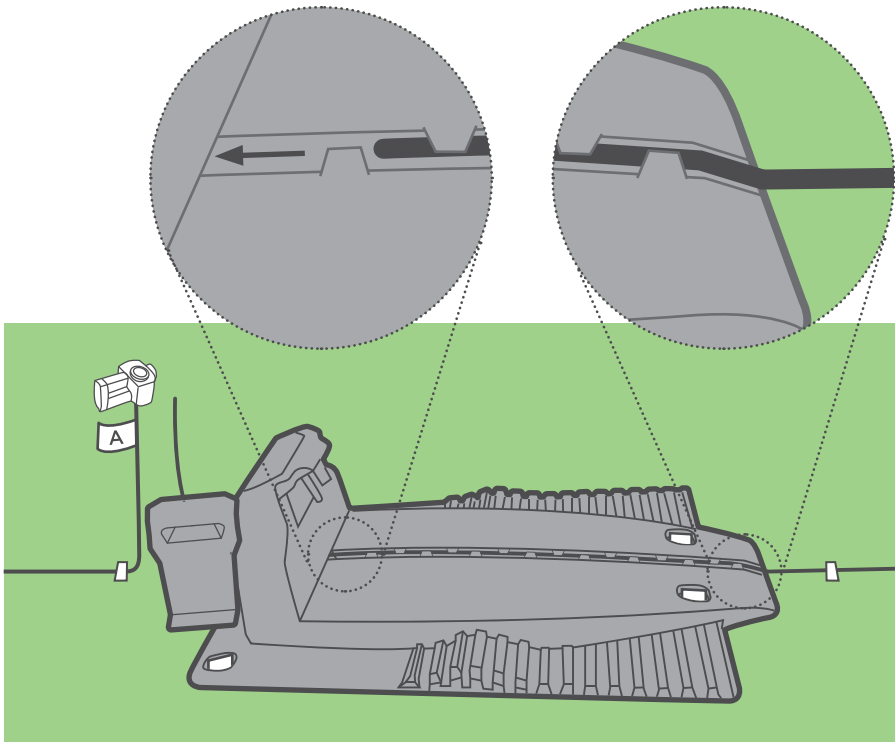

Install the connector to the tip of the wire as described in the drawings. Cut the wire end, close to the connector.

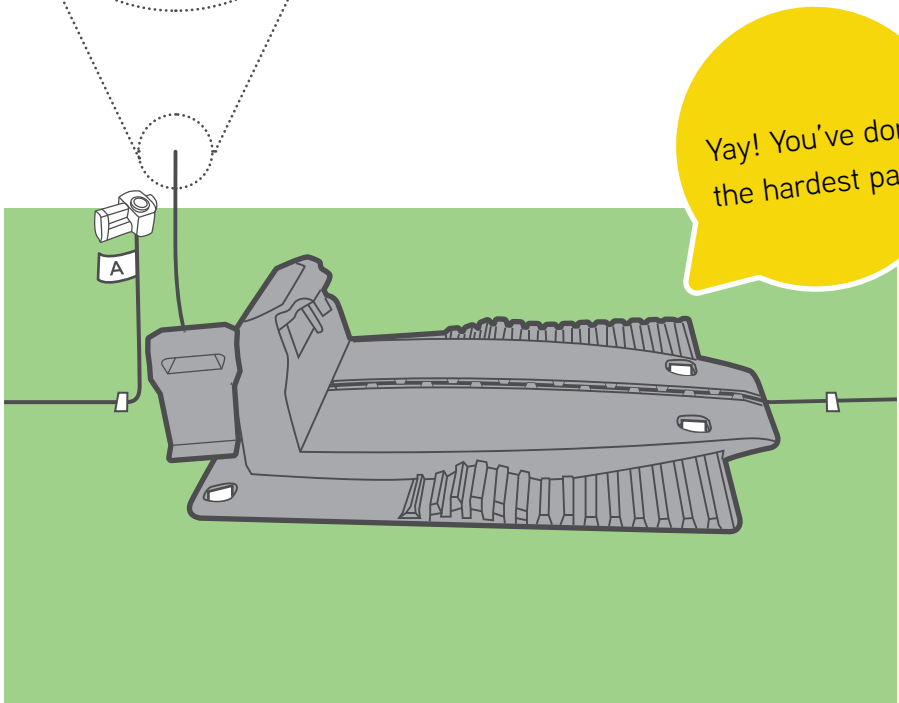
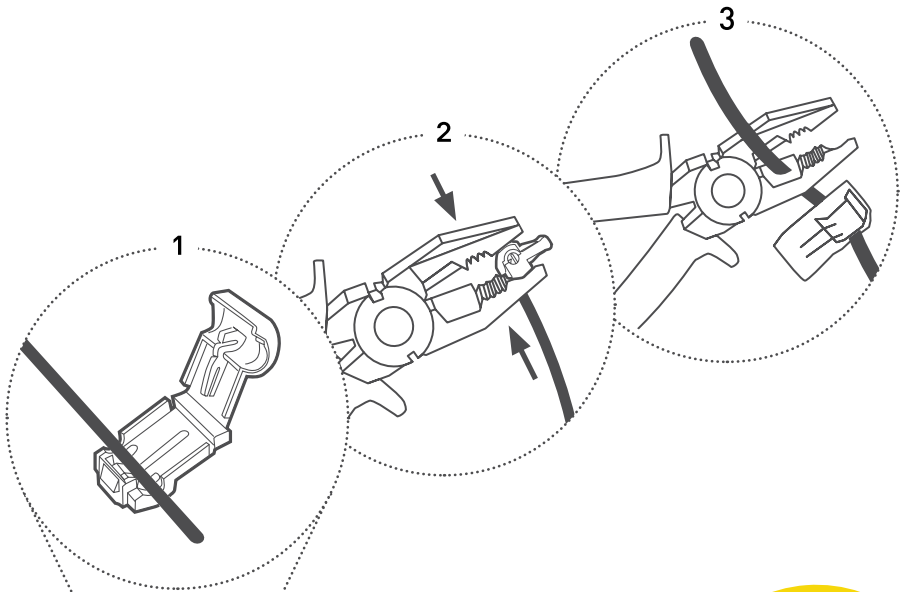

Peg the wire to the ground. Twist and wrap the wires so they could fit nicely in Base Station compartment. Connect the wire end marked with 'A' to the connector marked with A on the back of the Base Station. Connect the other end to the other connector. Tuck the wire in and close the door.

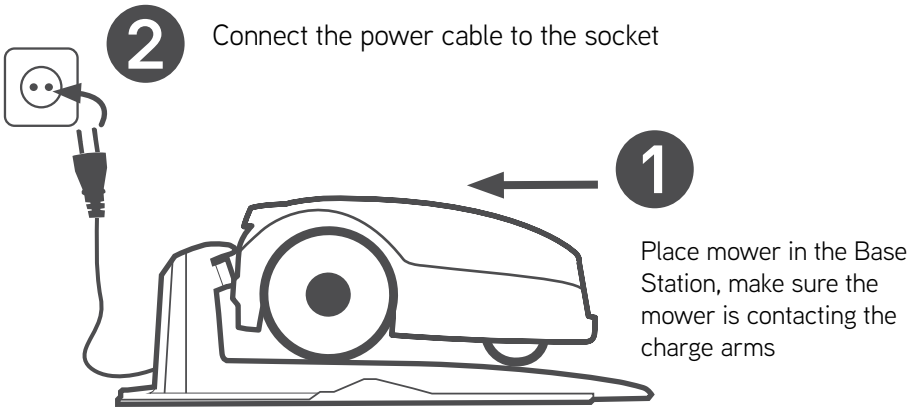
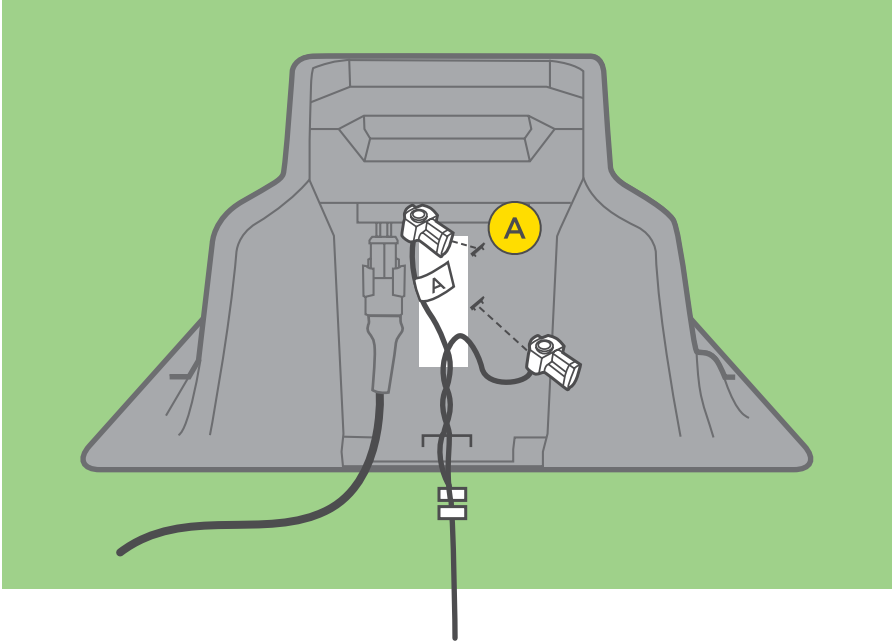







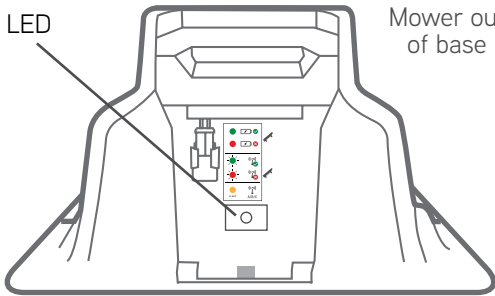





# LED Indicators

Now you should see the LED indication on the Base Station blinking green (if the mower is outside the Base Station), or steady green (if the mower is inside the base). More detailed information on the LED indicators is located on page 63.



Mower in base	Steady Green	 
	Steady Red	 
Mower out of base	Blinking Green	 
	Blinking Red	 
	Orange 4 sec	  4 sec      A/B/C

## Caution

The Extension Cable from the Power Supply to the Base Station should be securely fastened to the ground! It should never present a tripping hazard.

The Extension Cable should cross ONLY over soft surfaces. It should not cross over hard surfaces (e.g., sidewalk, driveway) where it cannot be securely fastened.



Just one more step to go...:)

# One Time Setup

Turn the mower on and follow the initial settings to get it ready for work.

## Set Language, Time and date

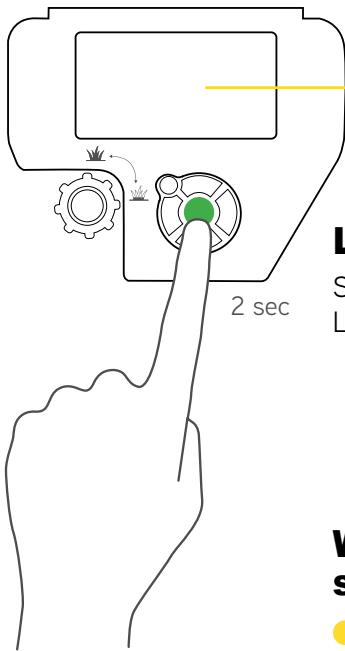

### Language

Select your Language

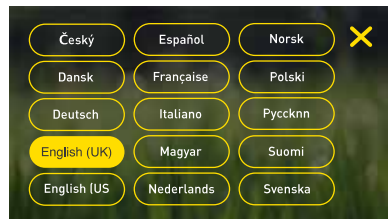

### Welcome screen

→ Next

← Back

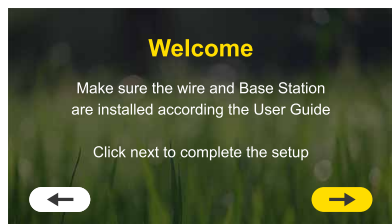

### Date

Set date

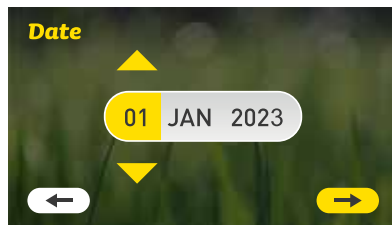

## Time

Set time

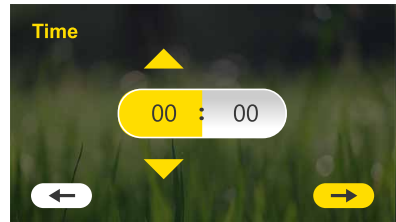

## Installation done by...

Select who is performing the installation.

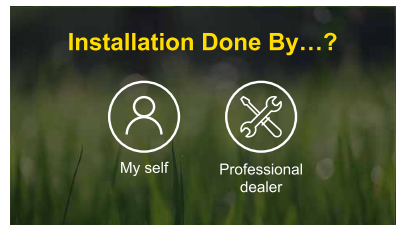

## Test wire position

Ensures the robot can follow the wire without obstructions. Your mower will follow the wire and stop wherever an adjustment of the wire position is needed. Follow the instructions on the mower screen. Read more in Annex B.

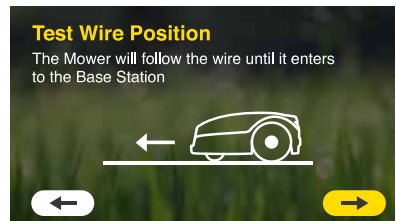

## What type is your lawn?

Choose 'Main+' if lawn has more than 1 zone.

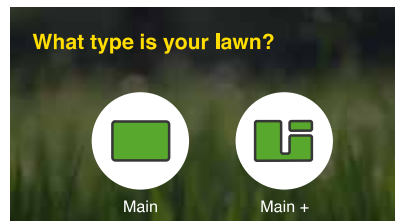

## Main Zone size

Set your Main Zone size.

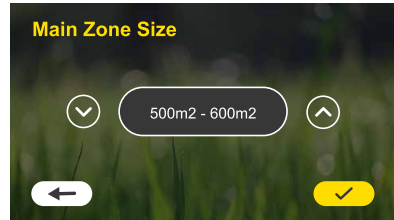

## Separated zone

If you have a separated zone in your lawn, you need to set the separated zone switch to 'ON'. This will allow you to select "Separated Zone" from the mower's home screen to initiate mowing after manually placing the mower in your separated zone. Remember to bring your mower back to the Base Station at the end of an operation in a separated zone so that it can charge and be ready to continue the automatic plan without missing an operation.

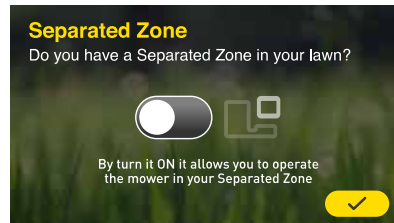

## Setup completed

Initial settings are done. The next screen will appear in a few seconds.

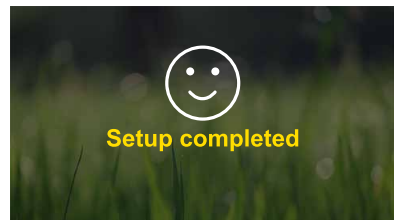

## Set Cutting Height

You can set the cutting height by rotating the Knob right/left. Once done press next.

If the grass is high, to get the best cutting results, it is recommended to start high and lower the mowing height gradually over a couple of weeks.



## Schedule Plan

The Mower calculates the suggested automatic mowing plan according to your lawn size. To start the automatic plan you need to approve it, or you can choose to change it from this screen or come back to it later for adjustment. You can find the automatic scheduling plan settings under the settings screen from the main screen.

You can read more information about the automatic plan settings options in the “Automatic Operation” section in this manual.

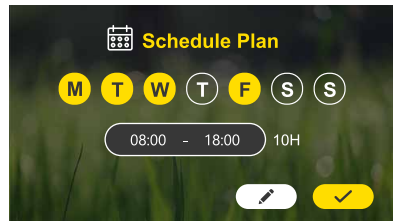

## Ready to mow

The one time setup is completed :)  
Your mower is now ready to mow.  
Confirm that it is in the base station and that the schedule plan is 'on'.

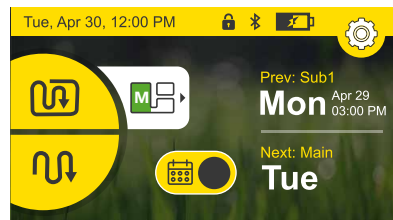

# Annex B - Test wire position

---

1. While your mower is driving on the wire please observe for the following possible situations:

a. Wire too close to obstacles

If the mower encounters an obstacle while following the wire, it will maneuver around it. In these situations, adjust the wire further away so that the mower will clear the obstacle without having to depart the wire and navigate around it.

b. Wire too close to edge of lawn

If the mower falls off the edge of the lawn as it travels the wire, adjust the wire further inward away from the edge.

c. Wire too far from obstacles and / or edge of lawn

Your mower has the unique ability to mow very close to obstacles and the edge of your lawn. If you see areas where it would not mow as close as you would like, simply adjust the wire further in. Just be careful to avoid situations “a & b.”

d. Rough or challenging terrain

If you see areas where the mower appears to have limited traction or is otherwise struggling to maneuver accurately, you should likely adjust the wire around these areas. Very loose or sandy soil, rocky or rooted terrain, and/or highly uneven surfaces can increase the chances of your mower getting stuck and not reliably making it back to the Base Station to charge every time. Areas that are very challenging in dry conditions are likely to become much more so after heavy rainfall.

2. To test any adjustments you make to the wire, simply press the stop control, and carry the mower to a location on the wire approx. 3 m before the area that was adjusted. Send it Home again. Repeat this process as many times, per location and on as many locations as necessary, until you are happy with how it navigates the entire perimeter.
3. Once the mower has made it all the way around the perimeter it will dock inside the base station.

## Secure wire

Now it's time to add some pegs along the wire.

Use the remaining pegs along the Perimeter Wire, between 0.5 m to 1 m (1.5 ft to 3.3 ft) apart.

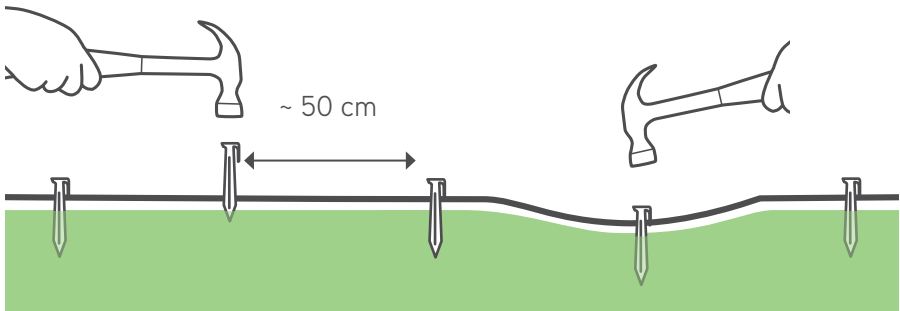
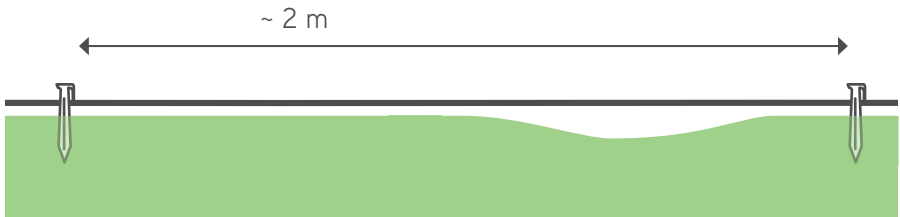



# Additional options with the mobile app

---

Your mower is a smart connected product. It comes with a built-in Bluetooth LE (Low Energy) device that enables you to control your mower from your smartphone.

A free complementary mobile app will allow you to experience your mower in a whole different way!

You can download the Robomow 3.0 app\* from Google Play Store (Android) or from Apple AppStore (iOS). After downloading, you can register your mower and enjoy much more.

Along with a totally exciting experience, it brings additional options and capabilities to your small and clever mower:

- Setting automatic mowing schedule
- Activating theft protection
- Defining lawn settings (size, sub-zones, separated zones)
- Manually driving your mower
- Mower diagnostics
- Avoiding interference by changing signal type
- Enabling "Storage" mode to minimize power consumption to comply with CEC/DoE regulation.
- Geo-fence and Push notification for models equipped with GSM module.#

\*Search Robomow 3.0 app in Google Play and App Store.

#Not available on models manufactured prior to 2022.

**Well Done!**

**Now relax, and let  
your mower do the  
work.**

- ① Knowing your mower**
- ② Menu structure**
- ③ Automatic operation**
- ④ Manual operation**
- ⑤ Features - how to**
- ⑥ Periodic maintenance**
- ⑦ Troubleshooting**
- ⑧ FAQs**

# 1 Knowing your mower

In order to fully enjoy your mower, learn about its different parts and messages. Understanding how it works and behaves will lead to its smooth and easy operation.

## External Parts

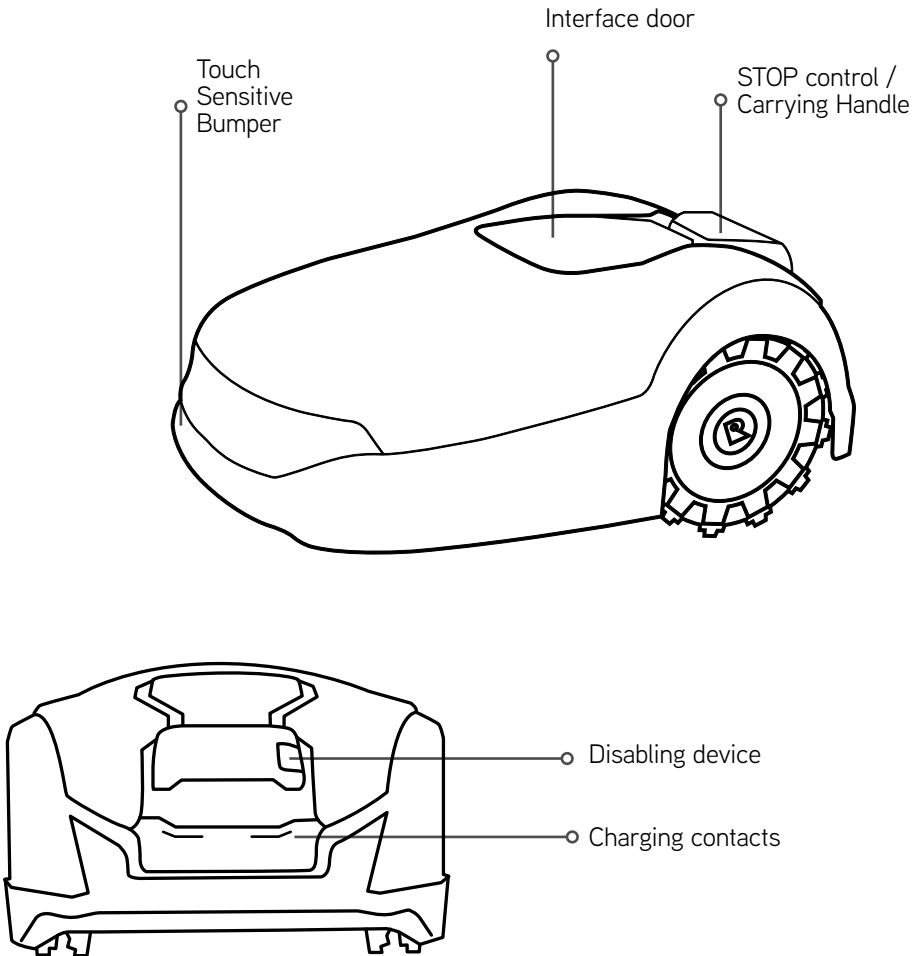

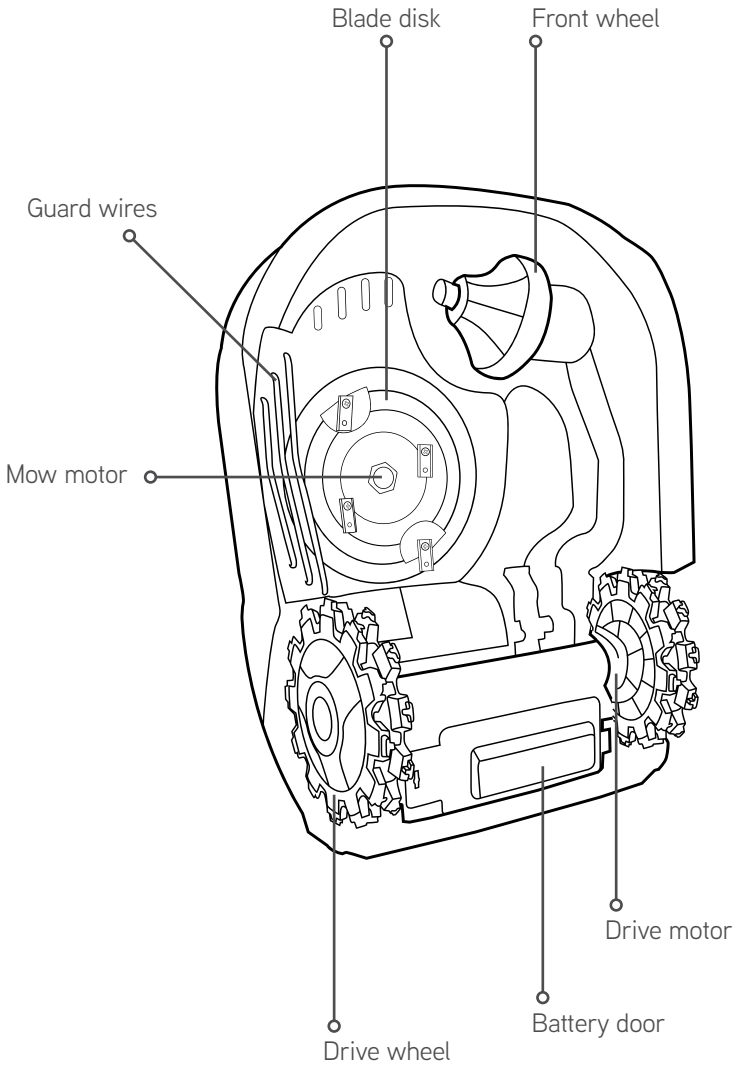

## Under the Hood Parts

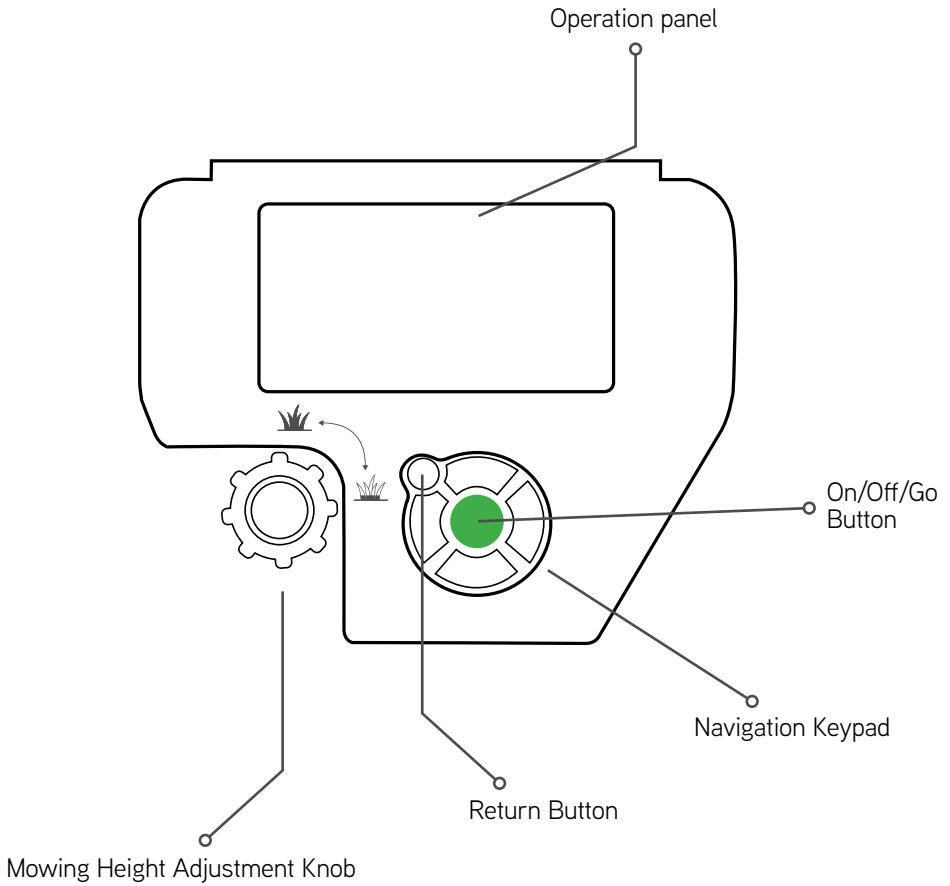



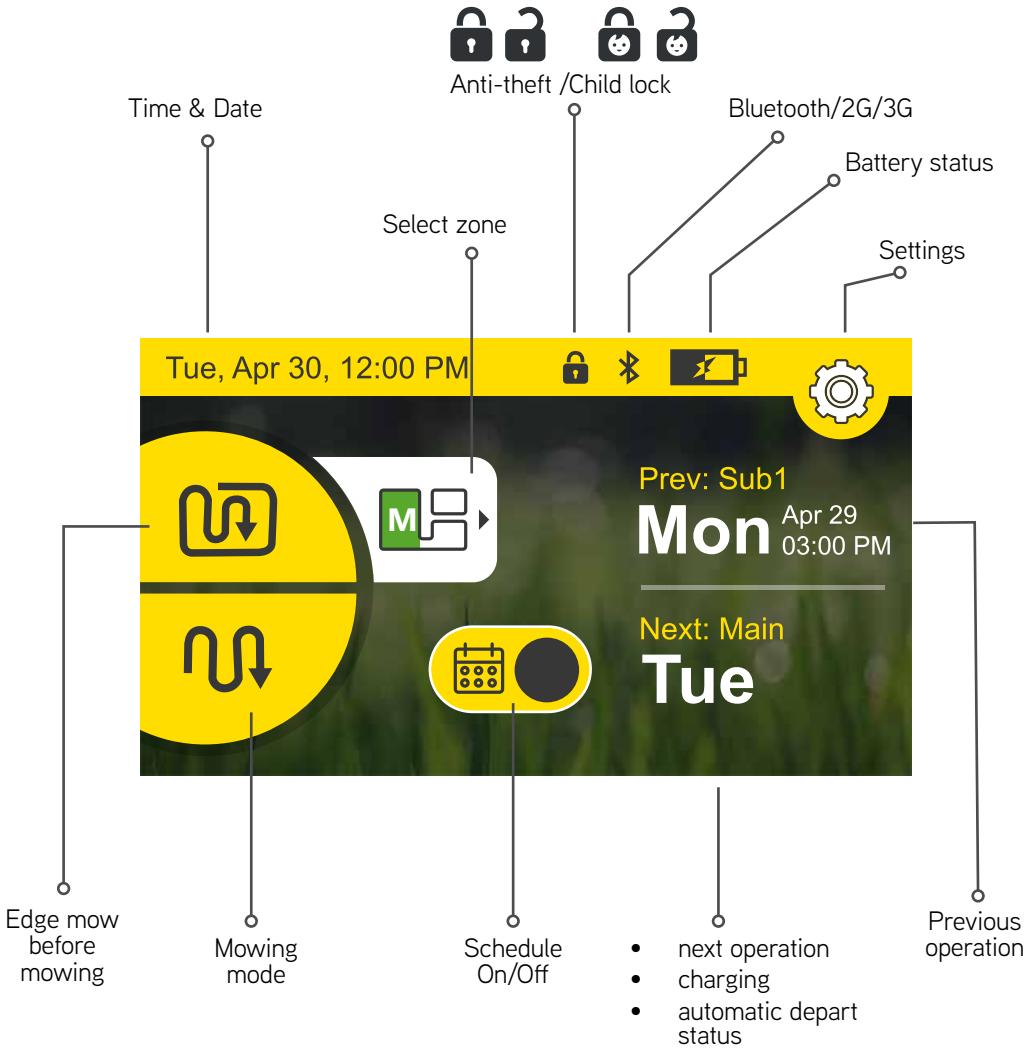

# LCD display

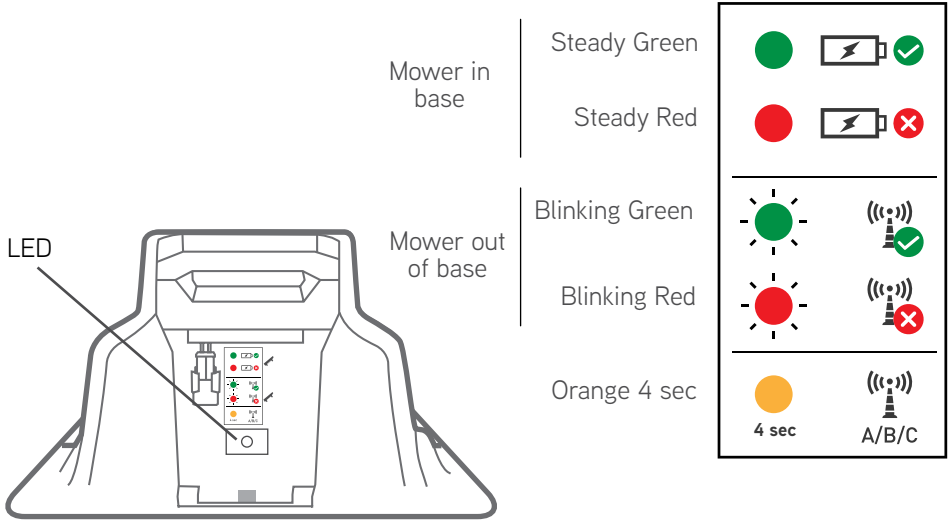

## Base Station LED indication



Indication	Meaning
 Steady green	Perimeter wire signal is OK; the mower is inside the base
 Blinking green	Perimeter wire signal is OK; the mower is outside the base
 Steady red	No charging
 Blinking red	Poor perimeter wire connection or the wire is too long
 Orange	Type signal has changed A/B/C



# 2 Menu structure



## Mower Options

Configure user preferences

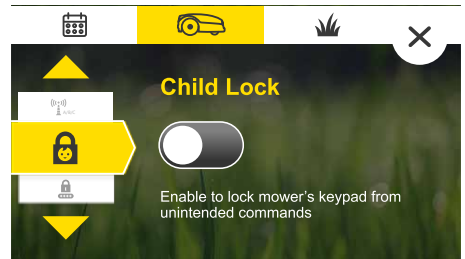
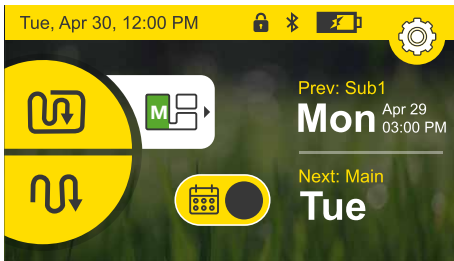

### Child Lock

Lock the keypad to prevent accidental operation



### Anti - Theft

PIN Code protection



### Time and Date

Set date & time



### Format

Select Time format (24/12) and Unit format (meters/feet)



### Language

Change mower's menu language



### **Sound**

Turn Sounds on/off



### **Signal Type**

Change to avoid interference with other robotic mowers around



### **Storage mode**

Minimizes power consumption during winter or other long periods where mowing is not needed while mower is left on base station.



### **Wire turn mode**

Allows more efficient mowing operation by enabling smooth, continuous turns at the lawn edge.



## **Lawn Options**

For a full description of all menu items, please refer to the Features section of this document. Additionally use the touch screen to navigate through menus by using the navigation keypad buttons and make a selection by pressing the green Go button.



### **Islands**

Turn On/Off



### **Size**

Set your lawn size



### **Add Sub-zone**

Add up to additional 4 sub zones to the schedule plan



### **Near Wire Follow**

Prevents wheel tracks along the same path by driving along the perimeter wire with a dynamic offset (not centered on wire)



### **Separated Zone**

Allows you to operate the mower in separated zones



### **Edge mow**

Enable or disable edge mowing on automatic operations



### **Intensive Mowing**

Temporarily increases the mowing intensity to maximum for 7 days

# 3 Automatic operation

Learn how to configure automatic operation and manually bypass/override it when needed

- The Zone Size setting is used by the mower to automatically determine the required mowing time for your lawn, and to recommend a weekly schedule for best results.
- This schedule includes the available working days, as well as the recommended working window available for each day.



- You can modify the working days and the working window according to your needs.

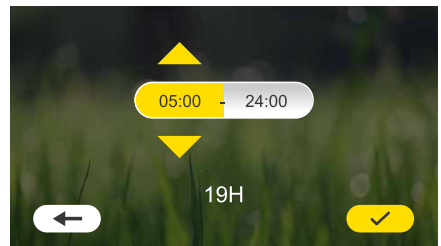

- You can split the daily working window into two separate windows if you'd like the mower to stay off the lawn for a time in between.

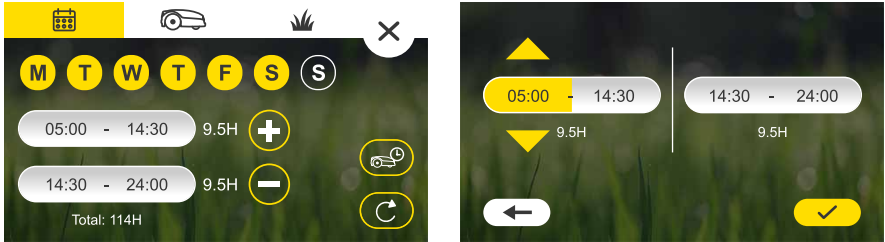

- It's important to not overly limit your mower's working time. Keeping the schedule open will allow your mower to better adapt to changing conditions and reach the needed working hours for the week.
- The mower will alert you (🔴) if the number of working days and/or size of the working window is not enough to accommodate the needed weekly mowing hours. For more information, tap the 'i' icon.



Your mower will stop mowing once it has reached the required hours for the week based on lawn size, so don't think of this schedule as necessary for preventing the mower from working too much.



**TIP**

## Mowing Hours

- Though your Robomow determines a smart schedule based on the size you set for your lawn, you may find the need to adjust from this at times.
- The mowing time required to maintain your lawn can vary on factors such as: grass type, weather / time of year, sunlight exposure, soil drainage, fertilizing, etc... Because of this, it is recommended that you monitor the quality of your lawn and make adjustments as needed.
- Your mower allows you to adjust the automatic schedule up or down, either for all your lawn together, or differently for each sub-zone.

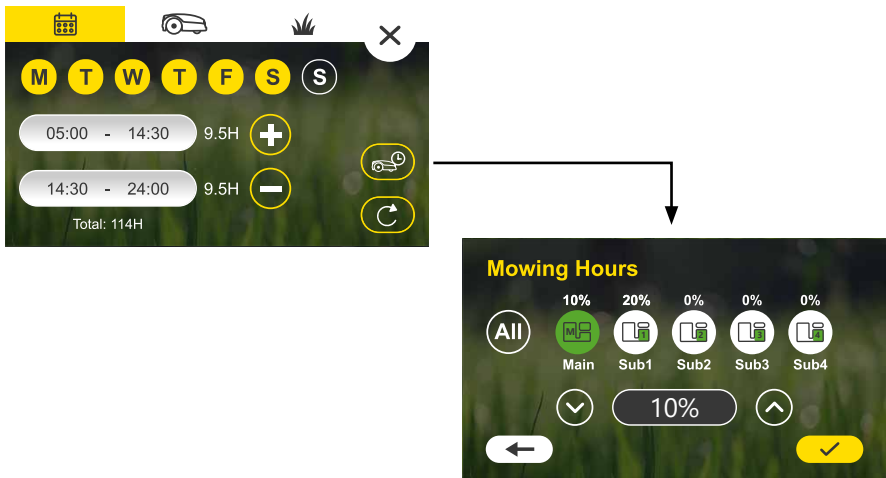

- 
- Too much mowing can damage your lawn and shorten the longevity of your mower
  - Too little mowing can result in an uneven look or the inability of the mower to keep up with grass growth
- 



## Note:

- For best results - It is recommended to not set more than 2 days in a row without mowing.
- After the necessary mowing is completed for a given day, the mower will stay in its Base Station until the next working day.
- By default the mower will be set with intensive mode switched 'On'. In this mode the mower will temporarily (for 7 days) work in the maximum capacity mowing mode. This is done to bring your lawn quickly to an even height before the mower switches into its automatic maintenance schedule.
- If at any time during the season, the mower has gotten far behind on coverage (possibly due to being switched off for an extended time, or because of a burst of very fast grass growth, etc...) you can re-enable Intensive Mowing to allow for the mower to catch back up. This will operate the mower at max. capacity for 7 days after which time it will change back to your previous schedule settings.



## Turning automatic operation on/off

- The automatic operation comes disabled by default.
- During the one-time setup, the mower will guide you to set your lawn size. When done you will be able to review the offered automatic plan, change it and enable it.
- If needed, you can switch off automatic departure completely by toggling the schedule on / off in the main screen.
- If you want, you can also stop automatic operation on a specific zone in the lawn settings section.



Schedule  
On/Off



# 4 Manual operation

Manual Operation is used when you want to start a mowing operation, regardless of the mowing schedule.

## Manual Operation with or without edging

To initiate Manual Operation:

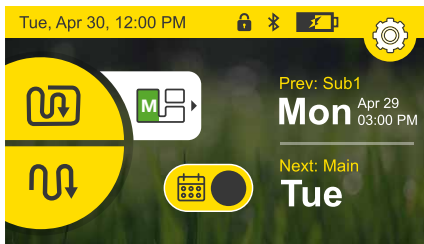

Choose between the two operation modes Edge+Mow or Mow.



## Select zone



Select the zone you want the mower to mow by tapping the select zone icon.

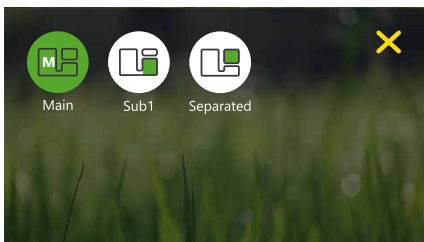

Select zone, then tap the Mow mode.  
Note: Edge mode is not available for Sub-zones.

# 5 Features - how to

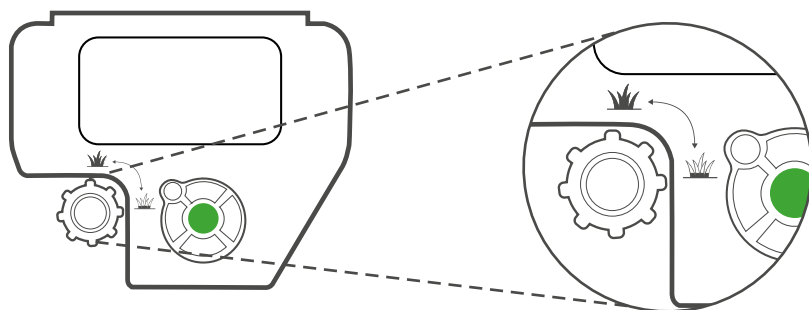

## Adjusting the mowing height

- Lift the interface door at the top of the mower.
- Set the mowing height by rotating the knob left or right. The cutting height is displayed on the LCD.
- The mowing height's range is 20-100 mm (0.8-4 in)



## Child Lock

This feature is turned Off by default. To turn this feature on:

Tap the settings  icon, then tap the mower  icon. Navigate to “Child Lock” and toggle On to enable.

After a delay of 10 min without touching the screen or keypads, the mower will become locked.

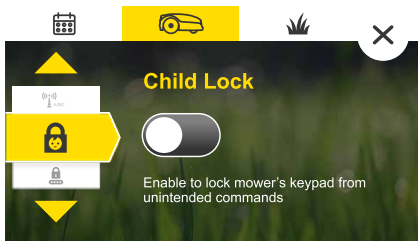

---

### To temporarily release locked keys:

Press and hold Up and Back buttons for 3 seconds.

The keys will relock after 2 min. without user intervention.

---

# Anti-Theft / Lockout

The Anti-Theft prevents anyone from using or driving your mower unless they have a valid code to enter. By default, this feature is turned Off. To turn it On for the first time:

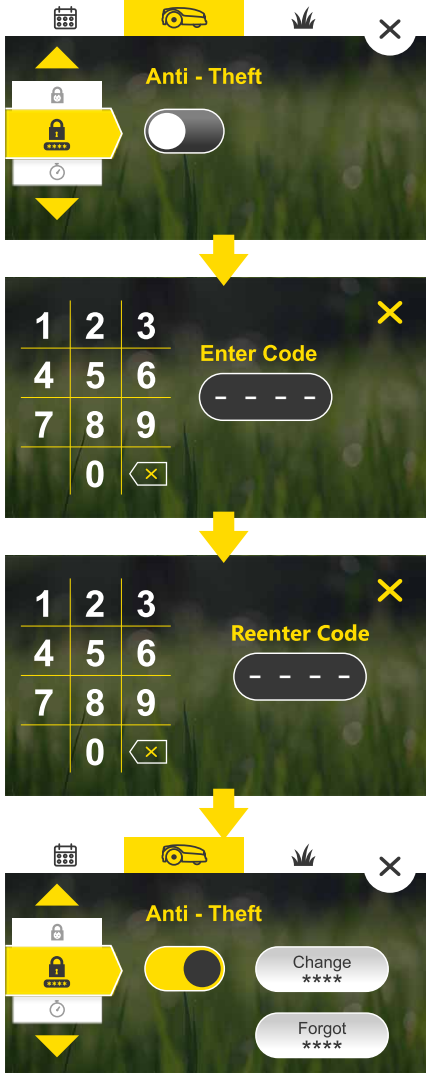

## Islands

If you have big islands (like ponds or large flower beds) in this zone you can set the 'Island' switch on to help the mower find its base more efficiently.



## Size

This is where you set your lawn size. Lawn size is important, as it is being used by your mower to calculate the amount of mowing hours needed.

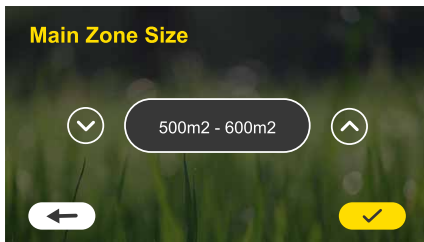

## Sub Zones

Use this section to add or modify sub zones. Just follow the screen instructions to choose the zone size, define the zone entry point, and set other parameters unique to each zone.

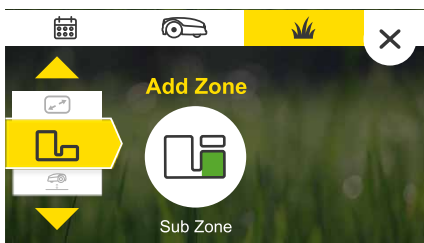

## Near wire follow

Use this feature to reduce wheel tracks along the perimeter when the mower travels back home to the Base Station. It works by allowing the mower to travel at various distances from the wire on each trip instead of always being centered directly over the wire.

Each lawn is different, so will require some experimentation to find the optimum min. and max. values.

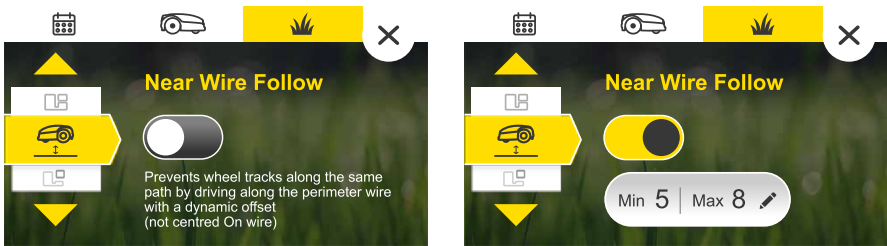

## Separated Zone

If you have a separated zone in your lawn, you need to set the separated zone switch to 'ON'. This will allow you to select "separated zone" from the mower's home screen to initiate mowing after manually placing the mower in your separated zone. Remember to bring your mower back to the Base Station at the end of an operation in a separated zone so that it can charge and be ready to continue the automatic plan without missing an operation.



## Intensive mode

If at any time during the season, the mower has gotten far behind on coverage (possibly due to being switched off for an extended time, or because of a burst of very fast grass growth, etc...) you can re-enable Intensive Mowing to allow for the mower to catch back up. This will operate the mower at max. capacity for 7 days after which time it will change back to your previous schedule settings (automatic operation needs to be turned on for intensive mode to be activated).

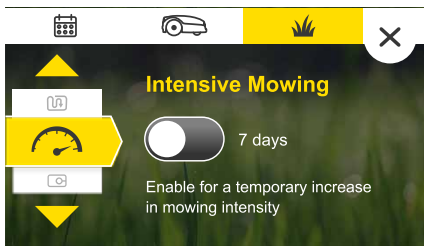

## Signal type

The mower supports 3 signal types that you can choose from in the case that you are experiencing interference from other robot mowers in adjacent lawns. To change the signal type, place the mower in the Base Station and select a different signal from the one you are currently using. Allow approx. 5 sec. for the mower to sync. with the Base Station on the new signal.

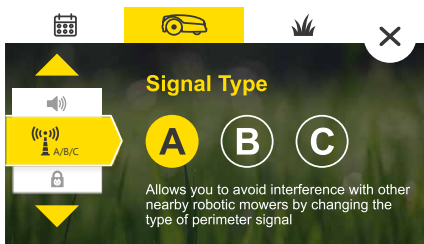

## Wire turn mode

Allows more efficient mowing operation by enabling smooth, continuous turns at the lawn edge.

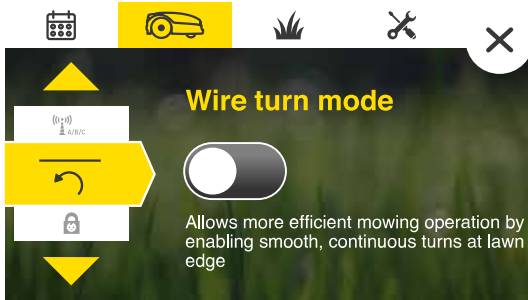



# Advanced Settings

## Storage mode

Minimizes power consumption during winter or other long periods where mowing is not needed while mower is left charging in the Base Station.

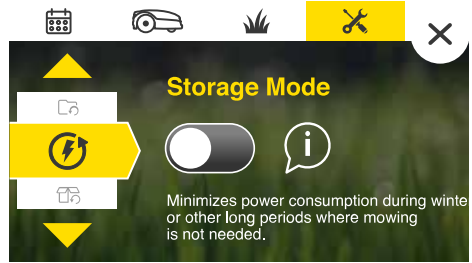

## Out of the box

Will reset all settings to the factory defaults. The one time setup mode will be initiated.



## Reset settings

This action will reset all mower and lawn settings including the automatic schedule plan.

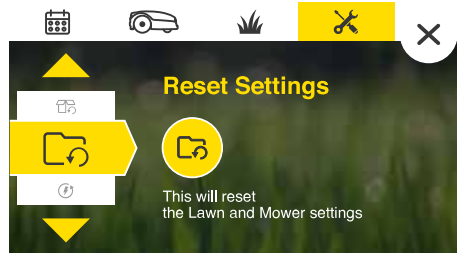

# 6 Periodic maintenance



## WARNING

Severe injury and damage hazard!

Always remove the disabling device and power the mower off before lifting the mower. Blades are very sharp. They can cause severe cuts or lacerations. Always wear heavy work gloves when working with or around the blades. NEVER use a damaged or broken blade.

After periods of ongoing prolonged precipitation it is advised to remove grass build-up from mowing deck, guard wires and wheels to ensure an ideal cutting result.

## Every couple of weeks

- Inspect the underside of the mower. Clean every couple of weeks if necessary. Carefully scrape the collected grass debris (using a small stick or similar object) from under the mowing deck.
- Check the Perimeter Wire and add pegs where it is loose and not tight to the ground. In case of seasonal changes in the lawn, make sure to adjust the wire accordingly.
- Inspect the Base Station, clean it from mud and debris to allow proper docking.



## IMPORTANT!

NEVER use high pressure water to clean the mower. Liquids can damage components. Use only a damp or wet cloth to wipe the surface clean after scraping.

# Winter storage

## The mower

- Turn Schedule Off and charge the mower fully in its base for 24 hours.
- Remove the disabling device and power the mower off.
- Clean the mower and store it in dry indoor conditions at ambient temperatures above 0°C.

## Base Station

- No winter storage is required for the Base Station. It can be left on the lawn during the winter period.
- It is recommended to disconnect the Power Supply from the mains during the winter storage period.

## Winter service

- To allow better maintenance and to keep your mower in good condition, it is recommended to bring it to a certified dealer for service prior to winter storage. Winter service is offered centrally in selected countries, or via 3rd party partners. Check Robomow website or contact us for more information.
- Winter service includes operations like cleaning the mower's parts and mowing deck, checking for worn parts (such as blades, drive wheels and other moving parts) and replacing them if required, testing the mower's functions and safety components, checking the battery, and uploading the latest software version, possibly including newly added features.

# 7

# Troubleshooting

Message Displayed	Probable Cause / Event	Corrective Action
Cross Outside	The Perimeter Wire is too close to the edge.	Move the wire towards the inner side of the lawn.
	The lawn slope near the edge is too steep and causes the mower to slip outside.	Do not include areas with very steep slopes near the Perimeter Wire.
	The lawn's edge is too bumpy.	Fill holes and pits along the edge until level with the ground.
Stuck In Place	The mower got stuck in place. It cannot continue driving.	Check the ground for holes or indentations. Fill it with soil. Check if the Perimeter Wire is not too close to the edge. Move the wire towards the inner side of the lawn.
	Check Mow Height	Mowing system is in overload due to very tall grass or an obstacle that is stuck or wrapped around the blades. Turn off the mower, remove the Disabling device and inspect the blades. Remove any foreign object or excessive clogging inside the mowing deck. Raise the mowing height.
Check Power	There is a temporary power cut.	Confirm that the Power Supply unit is plugged in to mains.
	The Power Supply unit is not plugged in properly.	Confirm the Power Supply is properly connected to the extension cable, and the cable is connected to the Base Station.
	There is no charging source detected.	Clean the charging contacts on the Base Station and verify proper connection of the Base Station to the Power Supply unit.
No Wire Signal / Waiting for Signal	Power Supply unit is unplugged or there is a temporary power cut.	Make sure the Base Station is connected to the mains supply.
	Signal generator may need to be restarted.	Disconnect the Power Supply from the mains supply and reconnect after 10 seconds.
	The Perimeter Wire is not connected to the Base Station.	Check the connection of the Perimeter Wire to the Base Station.
	The Perimeter Wire is cut.	Check for cuts in the Perimeter Wire.

# 8

## Frequently asked questions



### **Mower does not dock properly and sometimes misses Base Station's contacts**

The entrance to the Base Station is not flat. Fill some ground to flatten the lawn around the Base Station to allow smooth entrance. Make sure the Perimeter Wire is straight before and after the Base Station.



### **Poor quality of mowing**

The blades may be dull. Turn off the mower, remove the disabling device and replace them if needed. Use heavy gloves when inspecting blades.



### **Patchy and uneven mowing**

Make sure the working window is big enough and increase the mowing time via the **Mowing hours** setting to compensate for lawn's complexity or fast growing season.



### **Mower does not depart from base for a long time**

Tap the mower icon with the information bubble while the mower is in the Base Station. The non-depart reason code will be displayed. Refer to our online Help Center for a detailed description of non-depart codes.



### **Robot does not detect Base Station / 'Pairing Required' message displayed**

Remove mower from Base Station and turn it off. Make sure Base Station is active - plugged into a wall socket and green light is blinking. Turn the mower on and manually place it in the Base Station. Allow about one minute for pairing to be completed.



Stanley Black & Decker Outdoor GmbH | Wiesenstraße 9 | 66129 Saarbrücken | Germany