



User Guide

See how
to install



Original Operating Instructions



Robotic Mower
RS635 Pro SV, RS625 Pro, RS615 Pro, RS615u

 EN

*I'm
Robomow,
nice to
meet you.*



Your safety is important to us -

Please review this Manual carefully for all safety warnings and take extra caution to keep both children and pets off the lawn when Robomow is in operation.

Safety first 2

Installation 13

Quick reference 48

Safety first

IMPORTANT!

READ CAREFULLY BEFORE USE KEEP FOR FUTURE REFERENCE

- 1** ***Warning decal definitions***
- 2** ***Safety warnings & precautions***
- 3** ***Safety features***



Do not allow children to use or operate the mower. Children must be supervised at all times.

1

Warning decal definitions



1 2 3 4 5 6 7

1. This is a dangerous power tool. Exercise care when operating and follow all safety instructions and warnings.
2. Read the Safety Manual carefully before operating your mower.
3. Be careful of thrown objects during operation.
4. Keep a safe distance from the mower while it is operating. Keep people, especially children, pets and bystanders away from the area where the mower is operating.
5. CAUTION – Do not touch rotating blade. Keep hands and feet away and do not lift the mower from the ground.
6. Activate the disabling device before working on or lifting the mower (see Section 3.b).
7. Do not ride the mower.



Do not dispose of the mower or any of its parts as unsorted municipal waste. They should be collected separately.



This product conforms to applicable EU directives.



This symbol indicates that the mains electricity is double insulated

2

Safety warnings & precautions

A. Before you begin

1. Read this Safety Manual carefully before operating the mower to become familiar with its controls and proper use.
2. Never allow children, persons with reduced physical, sensory or mental capabilities or lack of experience and knowledge or people unfamiliar with these instructions to use the machine. Local regulations may restrict the age of the operator.
3. You are responsible for accidents or for harm to other people or their property.
4. It is your responsibility to inform your neighbors about the risks, and that it is forbidden to enter your lawn while the mower is operating.
5. If your lawn is open to the street and/or your neighbors, you must be present during the mower's operation to prevent others from accessing your lawn. Alternatively, you must protect / fence your lawn so that others do not access the mower during operation.

B. Preparations

1. Ensure the correct installation of the Perimeter Wire, as instructed.
2. Inspect periodically the area where the mower is used and remove all stones, sticks, cones, wires and other foreign objects.
3. Periodically visually inspect to verify that the blade is not worn or damaged. Replace a worn or damaged blade (Part No. MRK6101A).

C. Operation

IMPORTANT SAFETY WARNING!

Do not leave the mower to operate unattended if you know that there are pets, children or people in the vicinity. Never mow while people (especially children) or pets are nearby.



1. Do not operate the mower if any safety feature or any part is damaged, worn or inoperable.
2. Keep hands and feet away from the cutting blade and other moving parts.
3. Always switch off the Safety Switch before lifting it or planning to operate any adjustments.
4. Never pick up or carry the mower while the motors are running.
5. Do not touch the blade before it has completely stopped rotating.
6. Do not use the mower for any purpose other than cutting lawn.
7. Keep all guards, shields, safety devices, and sensors in place. Repair or replace damaged parts, including decals.
8. Set the weekly program at times when there are no people on the grass.
9. Do not connect a damaged power cord to the supply, or touch a damaged cord before it is disconnected from the supply as it can lead to contact with live parts.

10. Keep the extension power cord away from the blade to prevent the mower from damaging it. A damaged power cord can lead to contact with live parts.
11. If the power cord becomes damaged or entangled during use, detach it from the mains by pulling the plug from the socket.
12. In the event of accident or breakdown whilst the mower is operating, immediately press the red STOP button.

D. Transportation

Within the working area:

1. Press the STOP button to stop the mower.
2. Use the Remote Control.(available as an accessory or via the mobile App) to drive it from one place to another.
3. In case of different ground height level, switch off the Safety Switch, and carry the mower by its carrying handle (lift the STOP button for that).

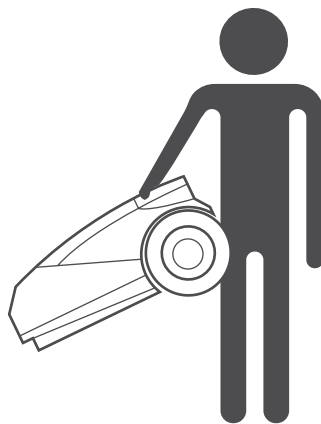

Long distances:

When transporting your mower over long distances, switch off the Safety Switch.



IMPORTANT! It is recommended to keep the original packaging for shipping purposes.

E. Using the remote control (manual mowing)

1. Mow only in daylight or in good artificial light, and avoid operating on wet grass.
2. Do not operate the mower barefoot or wearing open sandals. Always wear substantial footwear and long trousers; always make sure of your footing on slopes.
3. Use extreme caution when reversing the direction of the mower towards you.
4. Always switch on the motor according to the instructions while standing away from the blade.
5. Do not mow manually in slopes greater than 15 degrees or where a firm footing is not possible.

F. Batteries

1. Do not open or damage the battery pack.
2. The Battery Pack contains electrolytes. In case of an electrolyte leakage from the Battery Pack, the following actions should be taken:
 - Skin contact: Wash the contact areas off immediately with water and soap.
 - Eye contact: Immediately flush the eyes with plenty of clean water for at least 15 minutes, without rubbing.
 - Get medical assistance.
3. Ensure that the battery is charged using the correct charger recommended by the manufacturer. Incorrect use may result in electric shock, overheating or leakage of corrosive liquid from the battery.

G. Maintenance and special instructions

1. Always switch off the Safety Switch before clearing blockage/checking/cleaning/working on the mower, or after striking a foreign object to inspect the machine for damage. Never attempt to service or adjust the mower while it is in operation.
2. In case of abnormal vibrations, stop the mower, switch off the Safety Switch and check for any damage of the blade. Replace a worn or damaged blade (Part No. MRK6101A) to preserve balance. If the vibration continues, call for service.
3. Use heavy gloves when inspecting or servicing the blade.
4. Do not perform maintenance barefoot or wearing open sandals. Always wear suitable work shoes and long trousers.
5. Replace worn or damaged parts for your safety.
6. Use only original equipment and accessories. It is not permitted to modify the original design of the mower. All modifications are made at your own risk.
7. Ensure that only replacement cutting means of the right type (Part No. MRK6101A) are used.
8. Maintenance/servicing/cleaning of the mower should be according to manufacturer's instructions.
9. Keep all nuts, bolts and screws tight to be sure the machine is in safe working condition.

**WARNING!**

When there is a risk of a lightning storm, disconnect the Perimeter Wire from the Base Station /Perimeter Switch and the Power Supply 230 V/120 V plug from the power outlet.

H. Product end of use

1. The mower and its accessories should be collected separately at the end of their life to prevent waste electrical and electronic equipment from ending up in landfill sites, and to protect and improve the quality of the environment.
2. Do not dispose of the mower or any other of its parts (including the Power Supply and Base Station) as unsorted municipal waste - they should be collected separately.
3. Ask your local distributor/dealer about return and collection systems availability.
4. Do not dispose of the battery pack in a fire, and do not place used batteries in your household trash.
5. The battery must be collected, recycled, or disposed of in an environmentally sound manner.

3 Safety features



WARNING!

Your mower is equipped with numerous built-in safety features. However, the mower is a hazardous device with a sharp blade, which can cause major injury to anyone who comes in contact with it. Therefore, it is absolutely forbidden to be on the lawn while the mower is working. Alternatively, halt the mower's operation when people (especially children) or pets are to stay or play on the lawn.

A. Child Lock

The Child Lock prevents unintended operation of the mower by an accidental press of one of the buttons. Only pressing two buttons in the right order will initiate the operation. It is required to activate the Child Lock feature if children under age 6 may come in contact with the mower.

B. Anti-Theft/Disabling Device

The Anti-Theft/Disabling Device system function will prevent anyone from using or driving the mower unless they have a valid code to enter. You will be prompted to enter a four digit code of your choice to use as your personal security code. It is highly recommended to activate this feature to prevent operation of the mower by children or people who are unfamiliar with the mower or not allowed to use it.

C. Lift Sensor

If the mower is raised from the ground during the blade's operation, the blade will stop rotating immediately.

D. Tilt Sensor

If the mower is tilted up towards a vertical position, the blade will stop immediately.

E. Obstruction Sensor

Your mower detects interfering obstacles in its way during operation. When the mower collides with an obstacle, it will stop the rotation of the blade immediately, will stop movement in that direction and reverse itself away from the obstacle.

F. Emergency Stop Button

Pressing the STOP button at any time during operation will stop the mower and the blade immediately.

G. Safety Switch

Switching off the Safety Switch will prevent any operation of the mower. It is required to switch it off before lifting the mower and before any maintenance is done.

H. Base Station/Perimeter Switch and Perimeter Wire

The mower cannot operate without a Perimeter Wire installed and activated through the Base Station/Perimeter Switch. In the event the Perimeter Wire signal is turned off, the mower will stop operating.

**Let's get
started.
Can't wait
to mow your
lawn.**



Welcome to a friendly home

Congratulations on on your purchase! You are just a few steps away from meeting your best team player. Very soon you will come to count on your new friend to do a perfect job.

It will independently depart from its base on predetermined days and times, mow your lawn and return to base for charging

A preinstalled perimeter wire sets the boundaries (a “virtual wall”) for your mower. It will be laid around the edges of your lawn and objects that you want to protect.

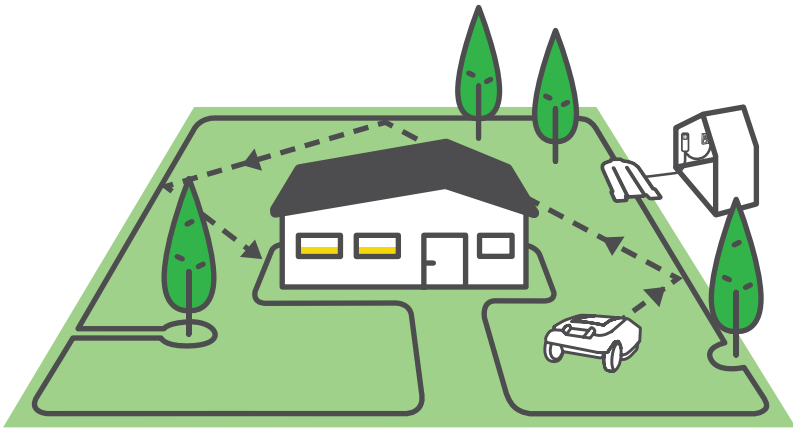

The mower moves randomly within its working area, as defined by the perimeter wire. This kind of random movement provides the perfect cut and ensures complete coverage of your lawn.

In addition, it follows the perimeter wire, when it mows the edges of your lawn to give it a perfect finish.

Good-looking lawns are achieved by consistent mowing, which is exactly what a robotic mower provides.

After following the clear installation instructions, you will be ready to enjoy your free time, while your new friend looks after your lawn.

So where are we headed?

Correct installation of your mower will ensure maximum results. This is what it takes to prepare it to do a perfect job for you:

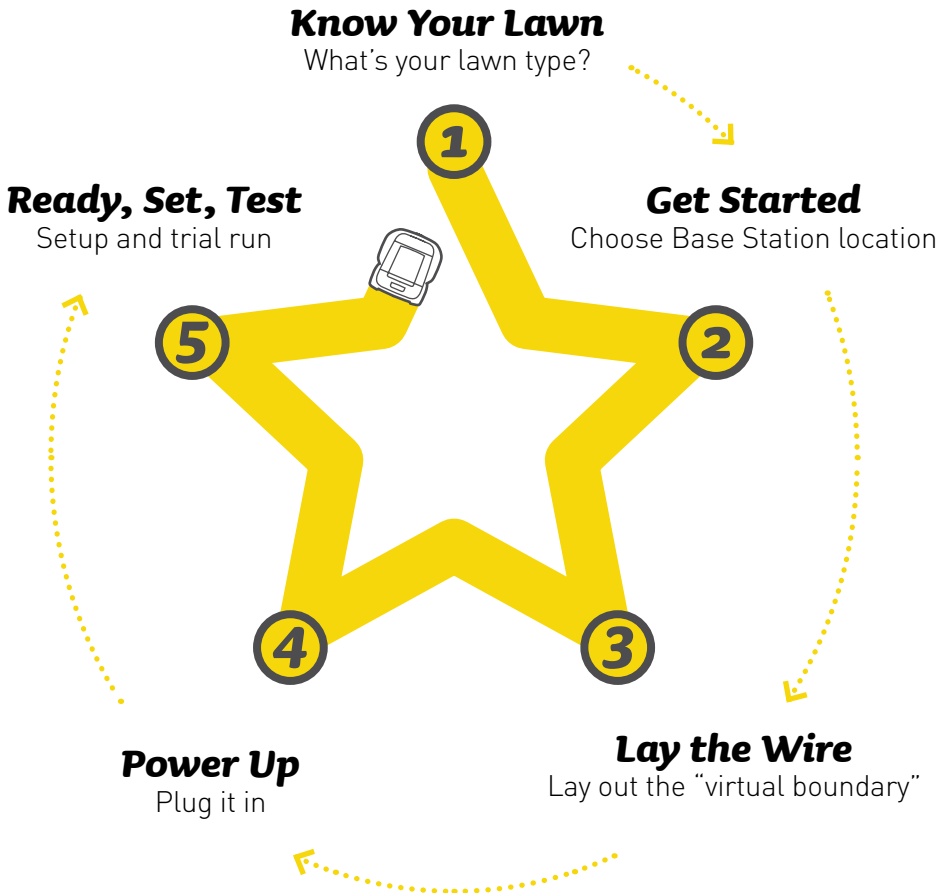

What's in the Box

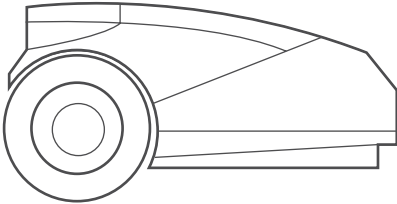

The product
Your new Robotic Mower



Extension Cable
20 m (65 ft) low voltage cable to connect the mower to the Power Supply unit

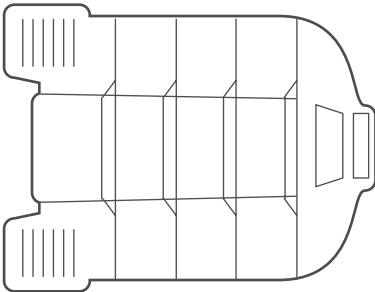

Base Station
This is where the mower recharges itself

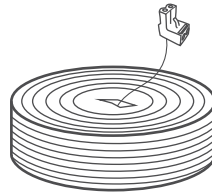

Perimeter Wire*
Marks the working area for the mower
() Not provided with Pro/XR3 models*

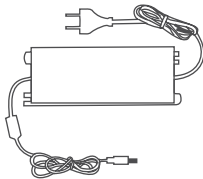

Power Supply
The power supply for charging your mower



User Guide



Blade Tool
For safe removal of the blades

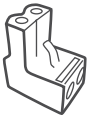

Spare Plot Connector
For connecting the Perimeter Wire to the Base Station

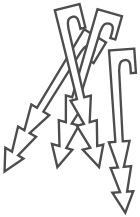

Wire Pegs*
For securing the wire to the ground
() Not provided with Pro/XR3 models*

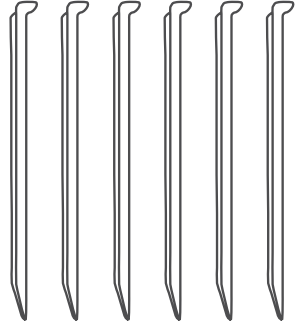

Base Station Stakes (x6)
For affixing the Base Station to the ground



Wire Connectors
For splicing the Perimeter Wire in case of a cut



Fuse
For preventing battery discharge during storage

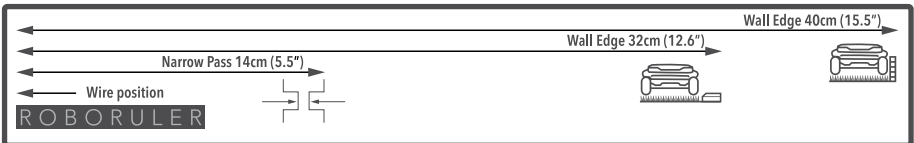

RoboRuler
For measuring the Perimeter Wire's distance from the lawn's edge

Ready? Let's begin...

1

Know Your Lawn

Understanding your lawn will save you unnecessary mistakes and make the installation process easier and more straight-forward.

You can also skip some later sections in this manual that are not relevant to your lawn type.

So, what does your lawn look like?

Type A

Main Zone only

Your lawn area is one continuous zone and all areas of the lawn are wide enough for the mower to navigate through (at least 4 m (14 ft) wide at its narrowest point).

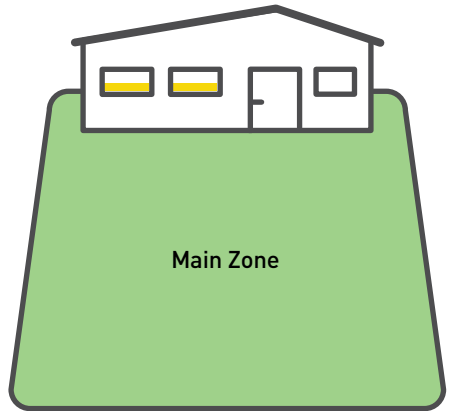

Type B

Main Zone + Sub Zone

Your lawn consists of more than one zone. These zones are connected by a narrow passage (1.5-4 m / 4.5-14 ft wide). The mower can drive between these zones to mow the entire area.

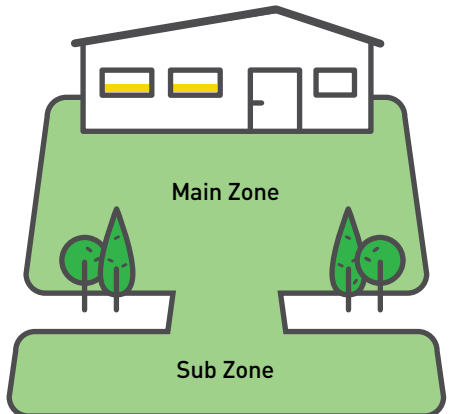

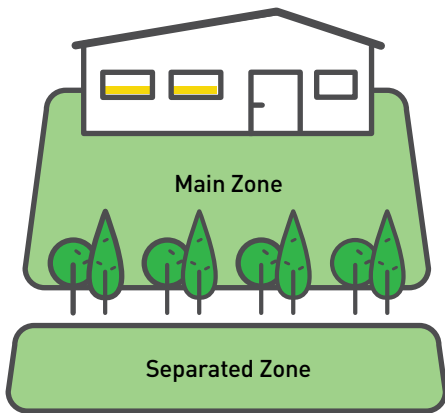

Type C

Main Zone + Separated Zone

Your lawn consists of two or more zones that are not connected (separated by a fence, sidewalk, pathway or other obstacle). The mower cannot drive between these zones.

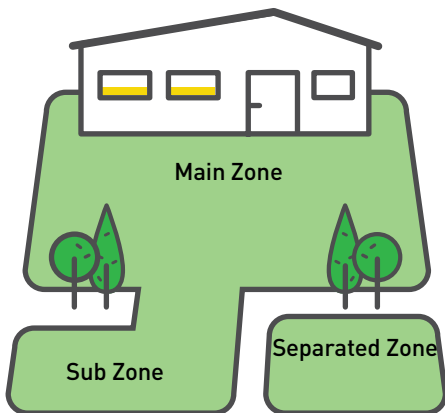

Type D

Main Zone + Sub Zone + Separated Zone

Some areas of your lawn are connected to the Main Zone by a narrow pass (up to 4 m / 14 ft wide) and some areas are totally separated from the Main Zone by a fence, sidewalk, pathway or other obstacle, and the mower can't drive between them.

2 Get Started

Choose locations for the Base Station & Power Supply unit

The Base Station is where your mower recharges, and where the perimeter wire starts and ends. In this installation step, you are going to determine a proper location for the Base Station.



The Base Station will be installed at a later stage, after the Perimeter Wire is in place.

Where should you place your Base Station?

Consideration A

Up to a max. of 20 m (65 ft) from a power outlet

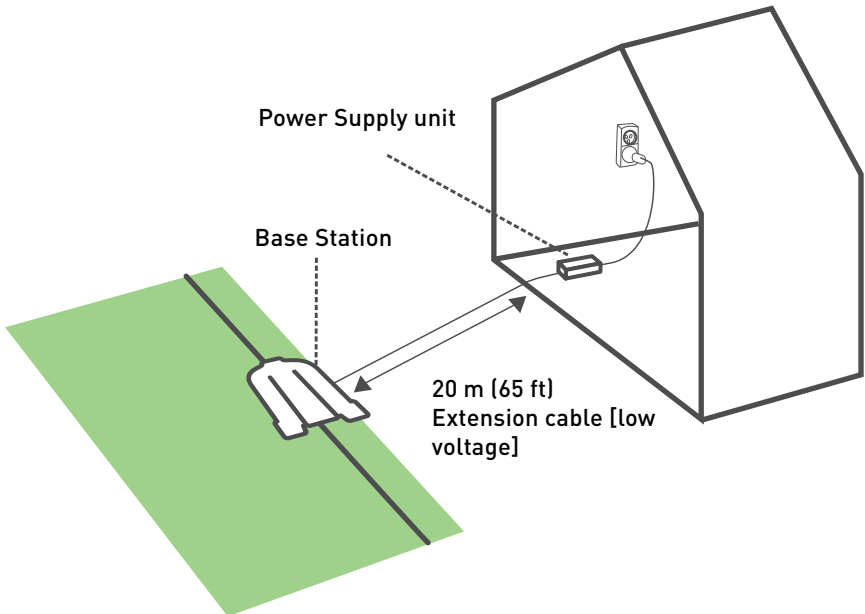

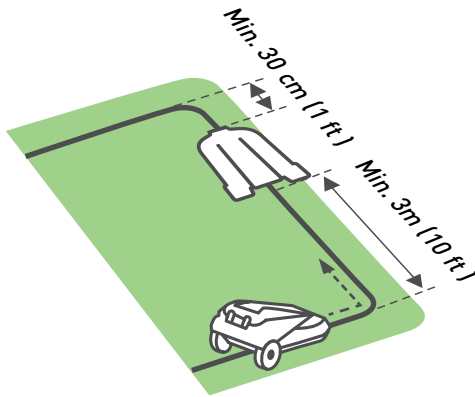

Consideration B

A min. of 3 m [10 ft] of straight wire in front of the base and a min. of 30 cm [1 ft] behind the base to allow smooth docking

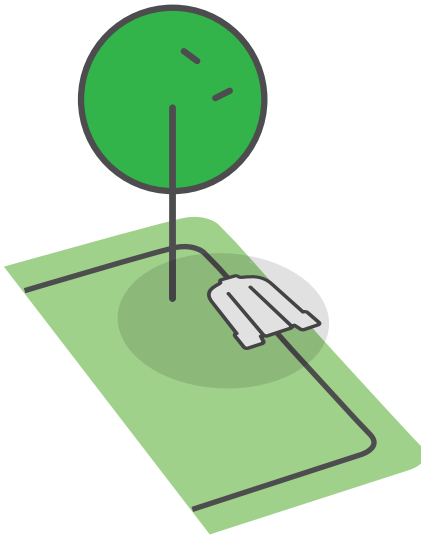

Consideration C

In a flat and shady spot

-
- If there are additional zones in your lawn, place the Base Station within the largest zone
 - Make sure the ground is even and flat, and that there are no slopes
 - Keep a minimum of 1 meter / 3.3 feet from a sprinkler head to avoid hitting the mower directly and damaging its internal components
-



TIPS

3 Lay the Wire

Lay the perimeter wire (“virtual boundary”), which defines the working area for the mower.

Now you’re ready to install the Perimeter Wire. Let’s take it step by step.



TIPS

- Have your mower’s package nearby.
- Be sure to cut your grass with your old mower one last time before you start wiring. This will make inserting pegs easier and help ensure that the mower doesn’t cut the wire.



WHAT YOU’LL NEED

- Hammer
- Small, flat screwdriver
- Combination pliers

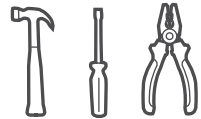

... A sunny day and a sunny mood :)

First Things First: Obstacles and Slopes

Before you put a single peg into the ground, take note of any obstacles or slopes.

OBSTACLES



Soft Obstacles

Soft obstacles are flower beds, ponds or small trees. They need to be protected by creating Perimeter Islands.

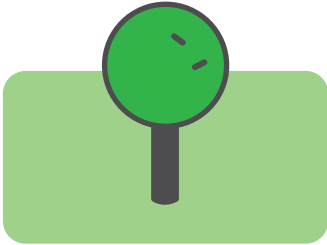

Hard Obstacles

Hard obstacles are vertical, rigid and higher than 15 cm (6 in), such as trees or telephone poles.

If a Hard Obstacle has a diameter under 10 cm (4 in), it must be protected by a Perimeter Island. If the diameter is larger, it's not necessary.

SLOPES

Slopes along the edge

To ensure your mower doesn't slip off the lawn, especially when the grass is wet, the Perimeter Wire must exclude a slope along the edge of your lawn with an incline of over 15% - that is, 15 cm rise per 1 m [6 in rise per 3 ft].

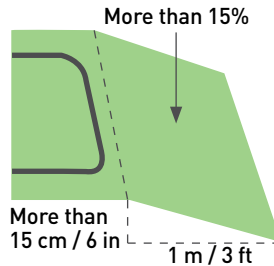
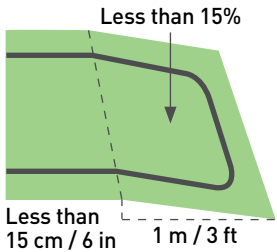

Slopes within the Lawn

Your mower can mow areas within the lawn with a slope of up to 35% [35 cm rise per 1 m/14 in rise per 3 ft].

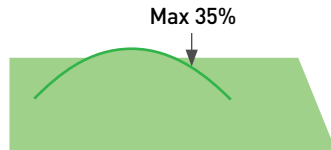

The slope is too steep if...

The mower tilts off the ground while climbing it. Exclude such slopes from the cutting area.



A. Make a Good Start

Before you begin, walk along the edge of your lawn and plan how to set up the Perimeter Wire. Take note of all obstacles and slopes.



Pull out approx. 30 cm (1 ft) of wire through the hole in the spool's plastic covering and peg the beginning of the wire to the ground where you intend to install your Base Station.

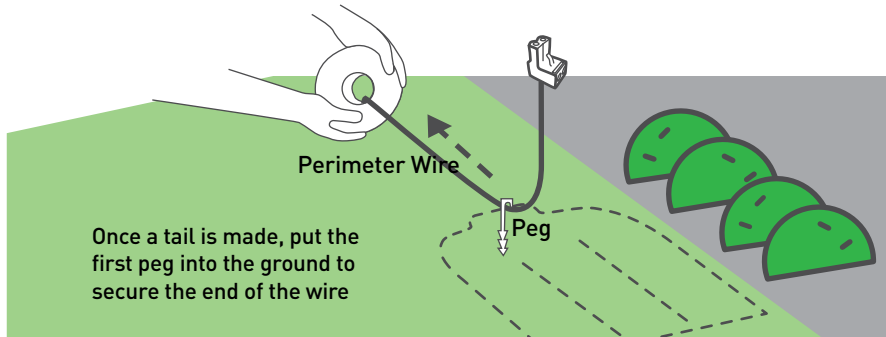

Start unwinding the wire counter-clockwise around the lawn, starting at the Base Station's location.

Lay it loosely along the perimeter as you walk along the lawn edge. If you get to any area/object that needs special care, make sure you carefully lay the Perimeter Wire as described in the following sections.

B. Maintain Proper Distance

The Perimeter Wire is secured to the ground by the pegs supplied with the product. Use the RoboRuler to determine the distances you should leave between the Perimeter Wire and the lawn's edge and obstacles.

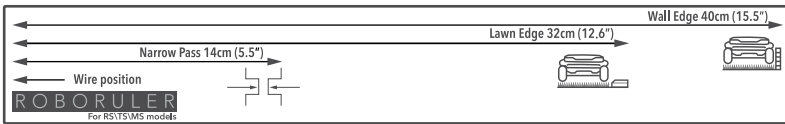
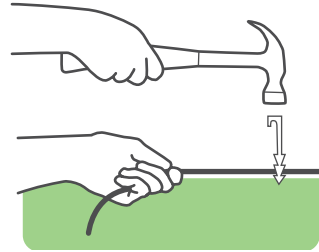

- Insert pegs every few meters/feet and at corners. At this early stage, set a minimal number of pegs. You will insert all necessary pegs later.
- Pull the wire tight while hammering the pegs to their final depth in the ground.
- Take care not to damage irrigation pipes.



When the edge is flat or a drop, use the short distance of the RoboRuler.

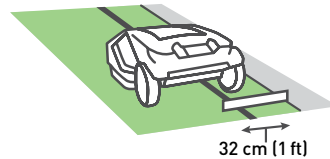

When the edge is a wall (more than 2 cm/1" above the ground level), use the longer distance of the RoboRuler.

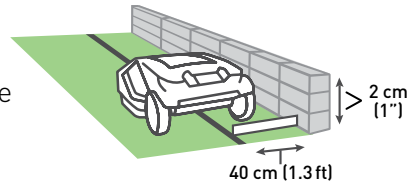

Leave a minimum of 1.2 m (4 ft) if the edge of the lawn borders water.

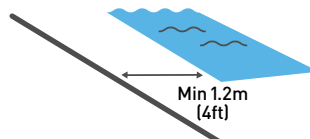



TIPS

- It is not necessary to bury the Perimeter Wire, though you may do so, up to 5 cm (2 in) deep.
- Burying the wire along exposed areas, such as pavements, is usually recommended.
- If additional Perimeter Wire is required in order to complete the setup, you can extend it using the waterproof Wire Connectors provided (see section 5-G “Splicing the Perimeter Wire”).

C. Make Smooth Turns

Maintain a 45° angle at all left-turn corners when laying the wire along the perimeter.

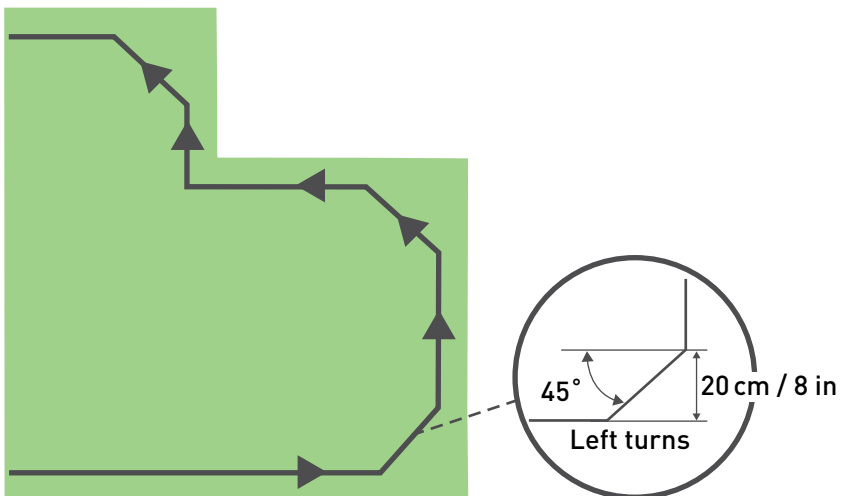

D. Protect Soft Obstacles

Objects such as flower beds, ponds, or small trees must be protected by setting Perimeter Islands.

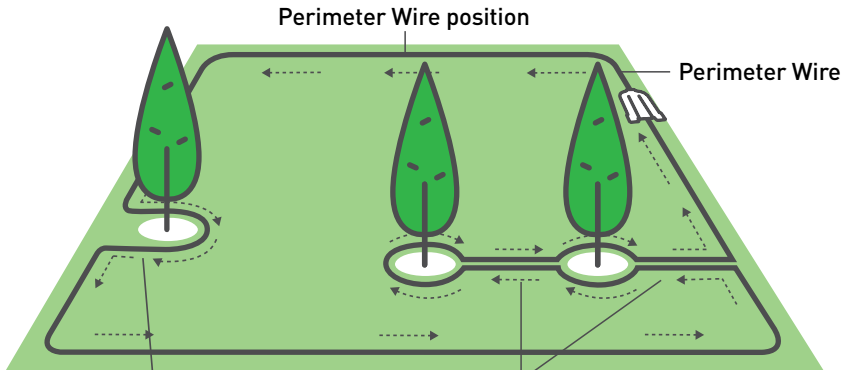

If the distance between an island and the perimeter wire is lower than 1.5 m (5 ft), make the obstacle part of lawn's edge.

Keep min. 1.5 m (5 ft) between islands; if obstacles are closer together, use one island.

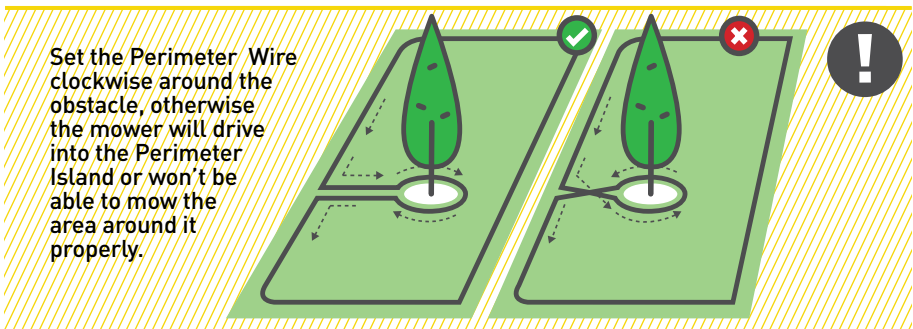

Set the Perimeter Wire clockwise around the obstacle, otherwise the mower will drive into the Perimeter Island or won't be able to mow the area around it properly.

- Wires leading to and from an island should be fastened with the same peg
- Perimeter Islands should either be rectangular or round



TIPS

Recall Your Lawn Type

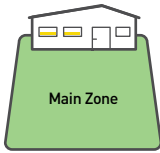

Type A
Main Zone only

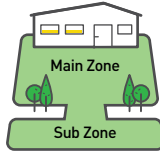

Type B
Main Zone +
Sub Zone

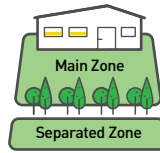

Type C
Main Zone +
Separated Zone

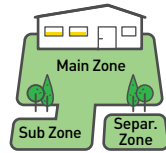

Type D
Main Zone +
Sub Zone +
Separated Zone

E. How to Wire a Sub Zone

Type B / Type D

*Don't have a Sub Zone?
Skip this section!*

A Narrow Pass connects the Main Zone with a Sub Zone. To allow your mower to drive through, it should be at least 1 m (3.5 ft) wide.

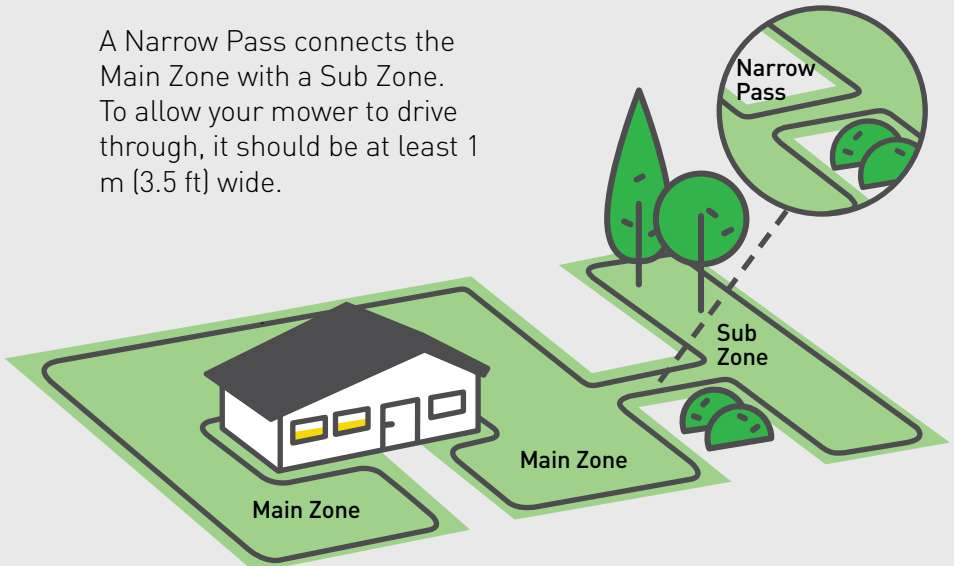

A helpful video
is available
online

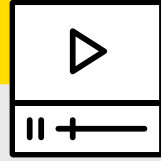

- If a Narrow Pass is shorter than 2 m [7 ft], set up only one square Perimeter Island in the passage
- Take care to wire Narrow Passes correctly to ensure that the mower doesn't cross into different zones spontaneously while mowing



TIPS

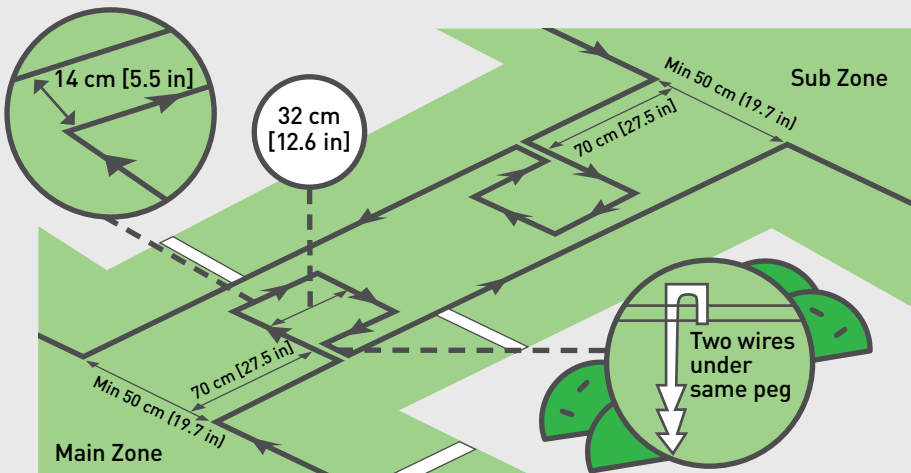

Narrow Passes should be firm, level, and smooth.

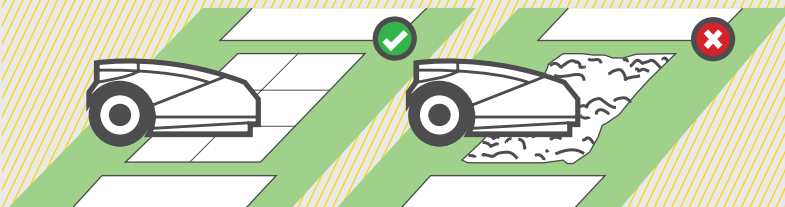

F. How to Wire a Separated Zone

Type C / Type D

*Don't have a Separated Zone?
Skip this section!*

If your Separated Zone is larger than $120 \text{ m}^2/1291 \text{ ft}^2$ ($200 \text{ m}^2/2150 \text{ ft}^2$ for models over $3000 \text{ m}^2/30000 \text{ ft}^2$), your mower won't be able to finish it in a single operation. Therefore, it is recommended to wire it separately and connect it to its own Base Station.

If your Separated Zone is smaller than $120 \text{ m}^2/1291 \text{ ft}^2$ ($200 \text{ m}^2/2150 \text{ ft}^2$ for models over $3000 \text{ m}^2/30000 \text{ ft}^2$), you can wire it in one of two ways.

OPTION 1 Extend the Perimeter Wire from the Main Zone, over the obstacle.

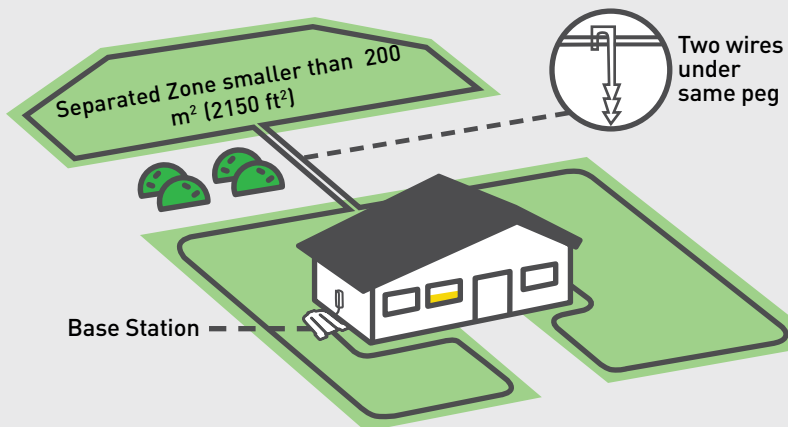

OPTION 2 Wire the Zone separately and connect it to a Perimeter Switch (optional accessory).

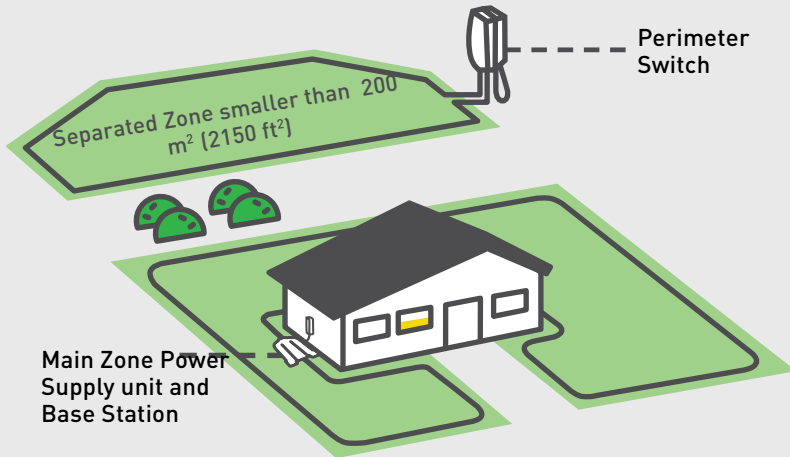

G. Complete Wire Setup

Once the Perimeter Wire has been laid completely, the two ends of the wire that meet at the Base Station should be joined together.

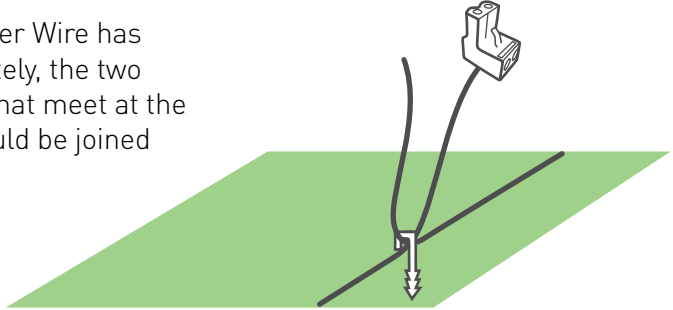

TIPS

- Use the same peg to fasten both tail ends of the wire to the ground
- Trim the ends so both wires are the same length



Make sure you twist the two wires together properly.

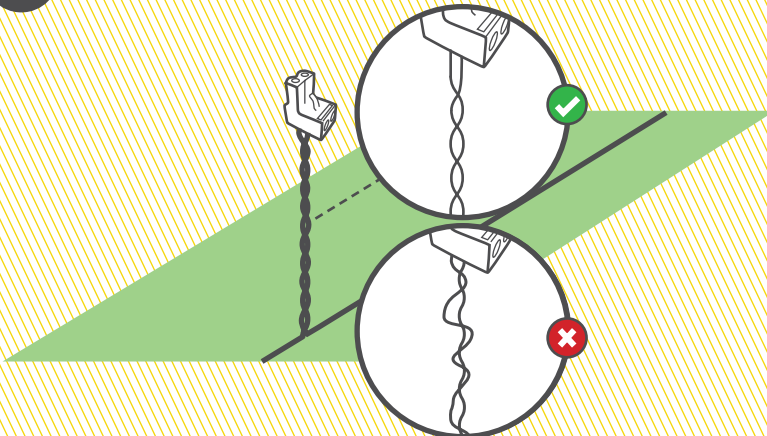

Strip back 5 mm (0.2 in) of insulation from the wire ends, insert the twisted wire into the connector and secure it using a small flat screwdriver.

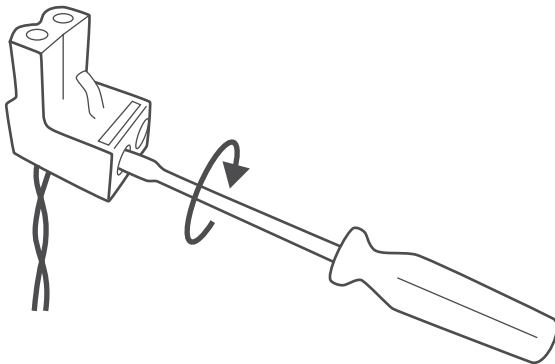
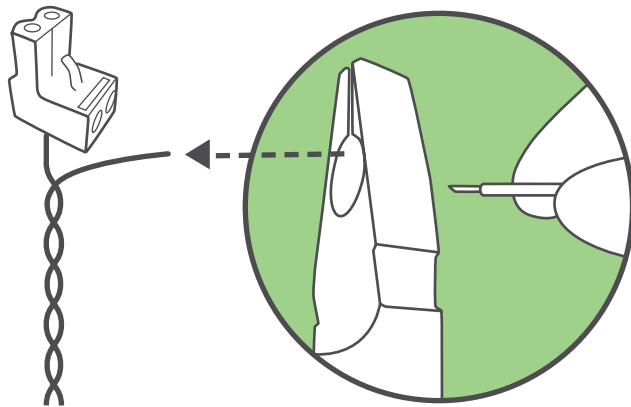

Yay! You've done the hardest part!

4 Power Up

Install and connect the Base Station and Power Supply

A. Install and Connect the Base Station

Place the Base Station in its planned location.

Remove the Base Station's head from the Base: **A.** Pull the lever upward. **B.** Push the Base Station's head from the front side in the direction marked.

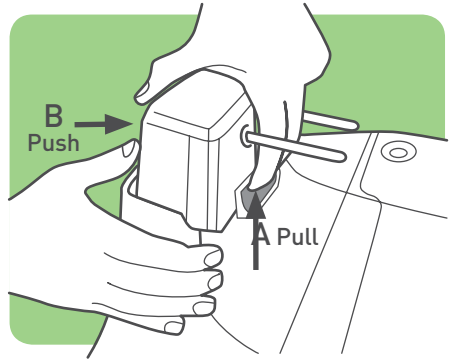

Feed both the Perimeter Wire (A) and the extension cable (B) through the slot in the rear side of the Base Station.

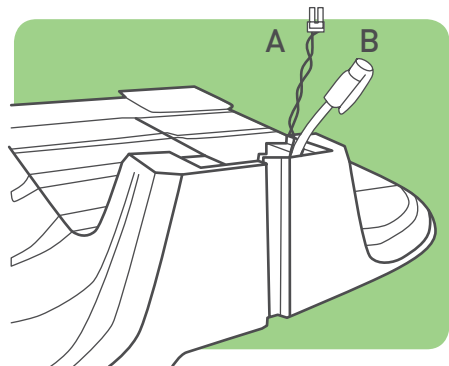

Attach the Perimeter Wire connector to point A on the Base Station's head. Attach the 20 m (65 ft) extension cable to point B on the Base Station's head.

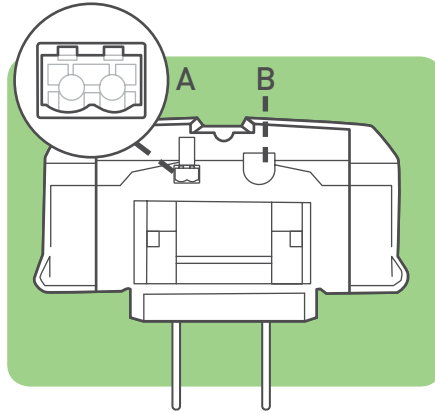

Slide the Base Station's head back into place on the sliders (C). Make sure it is inserted properly all the way through. Press the lever down until it clicks in place.

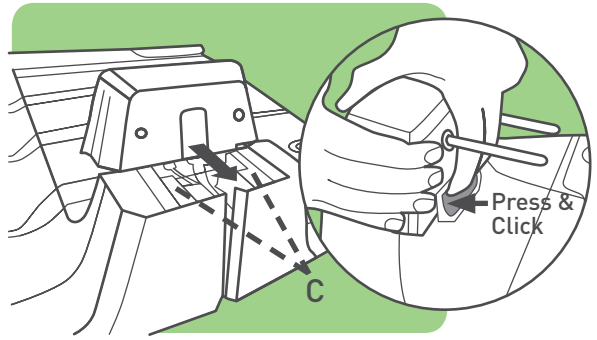

Feed the Extension Cable into the Power Supply unit.

Place the Base Station in its location and align it so that it's centered over the Perimeter Wire. Insert two stakes as shown. The remaining stakes will be inserted at a later stage.

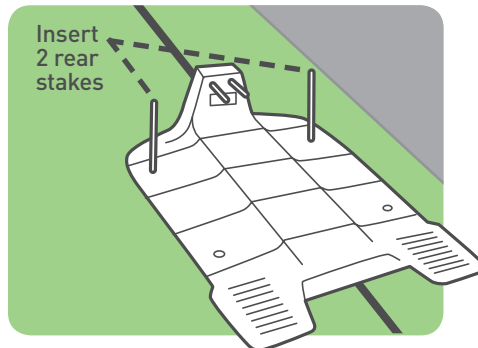

Be careful not to damage irrigation pipes when hammering down the stakes.



B. Connect the Power Supply unit



TIP

Consider the following in order to select a proper location for the Power Supply unit:

- Select a suitable location near a power outlet
- Position it outside the lawn perimeter
- A dry and sheltered location is preferable

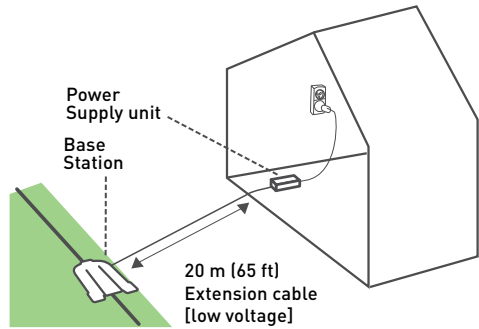

Connect the DC cable from the Power Supply unit to the 20 m (65 ft) extension cable.



Make sure the connector is inserted the whole way up to the white mark.

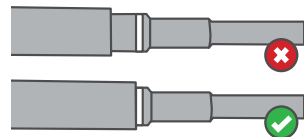
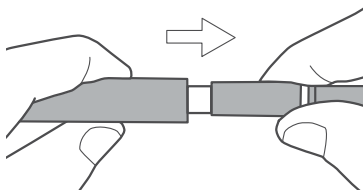

Connect the Power Supply unit to a regular power outlet.

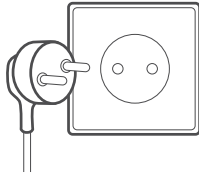

Now you should see the LED indication on the Base Station blinking green (if the mower is outside), or steady green (if the mower is inside the Base Station).

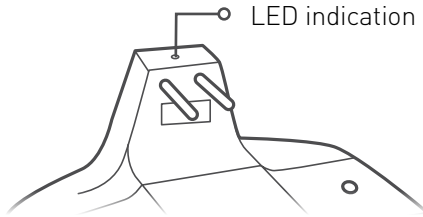

Caution

The Extension Cable from the Power Supply to the Base Station should be securely fastened to the ground! It should never present a tripping hazard.

The Extension Cable should cross **ONLY** over soft surfaces. It should not cross over hard surfaces (e.g., sidewalk, driveway) where it cannot be securely fastened.



Just one
more step
to go...:)



Ready, Set, Test

Prepare your mower and give it a test drive.

Congratulations! Now you are ready to give it a whirl.

WHAT YOU'LL NEED:

- The mower
- Remaining Pegs
- Remaining Base Station stakes

... *A glass of champagne (or equivalent)*

A. Start up

There are a few things to do before your mower can start.

Adjust the cutting height (20-80 mm/0.8-3 in) by turning the mowing height adjustment knob while pushing it down.

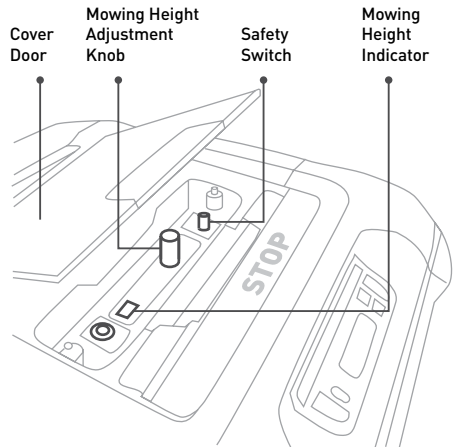

Insert the fuse.

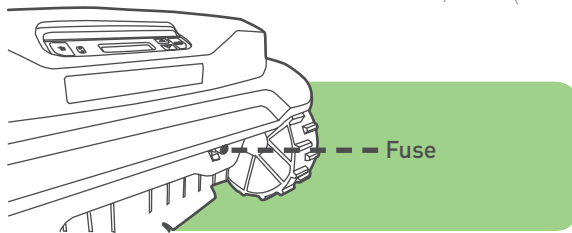

Caution Make sure the fuse holder is fully screwed in.



Switch on the Safety Switch.

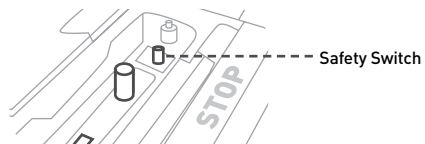

B. Set Basic Settings

Follow the instructions on the screen for a quick initial configuration.

Caution

Your mower has enough power to complete the configuration. Then, before mowing for the first time, you'll need to do a first-time charge that will take up to 24 hours.



Set Language

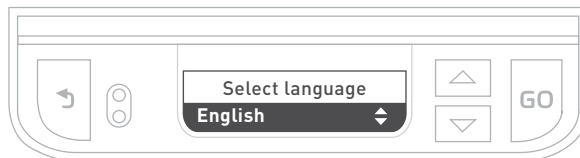

Scroll with the arrows to select the desired value. Press GO to confirm the selection and move to the next item. To go back a step or cancel an action, press the back arrow.

Set Date

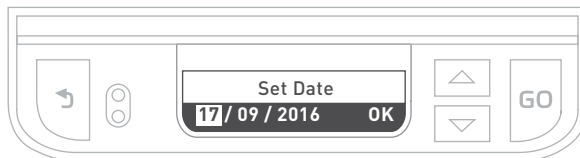

Set Time

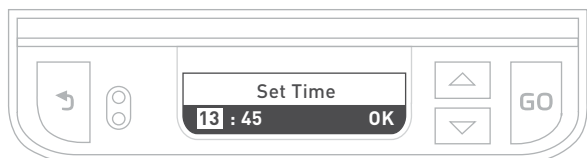



TIPS

To restart the setup at any time, press and hold STOP + down arrow together for at least 4 seconds.

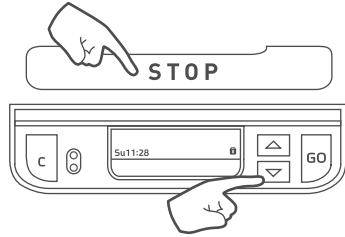

C. Test Base Station Position

Place the mower on the lawn, 3 m (10 ft) in front of the entrance to the Base Station, facing the Perimeter Wire, and press GO to start the test.

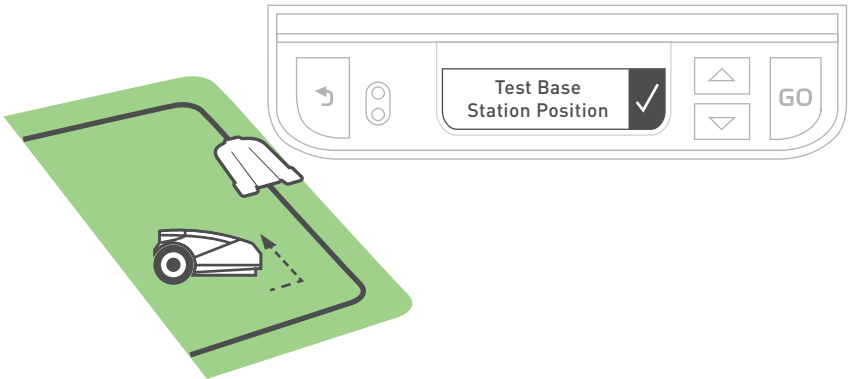

The mower will drive to the Base Station and enter it.



Next, it will drive out and wait in front of the Base Station and tell you to Peg Base. Insert the remaining four stakes into the Base Station. Press GO.

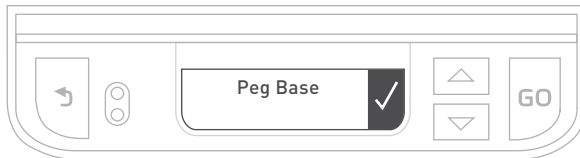

- If the "No wire signal" message is displayed, check that the Power Supply unit, extension cable and Base Station wires are all connected properly. Check for possible Perimeter Wire cuts.
- If the "Change wires in plot connector" message is displayed, swap the wires at the plot connector.
- If the "Reposition Base Station" message is displayed, check that the Base Station is aligned with the Perimeter Wire. Move any obstacles preventing entry into the Base Station.
- Be careful not to damage irrigation pipes when hammering down the stakes.



D. Test Perimeter Wire

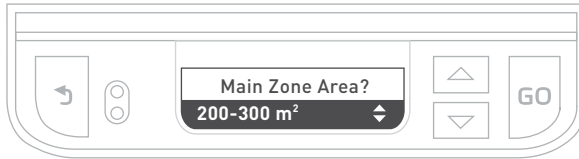

Enter the size of your Main Zone area. When you see the message "Test wire position," it means your mower is ready to test. Press GO. It will start driving.

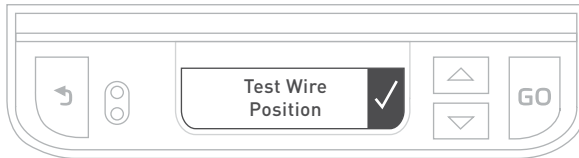

Walk alongside as the mower tours the perimeter. At the end of a successful tour the message "Wire test succeeded!" will be displayed and the mower will reenter the Base Station. Press GO.



If the "Adjust wire" message is displayed and the mower stops and drives backwards, move the wire slightly inward and press GO to continue the wire test.

E. Add Sub Zones

The mower will now prompt you to add any additional Sub Zone(s). Select X to skip this section if you don't have any Sub Zones.

If you select the Sub Zone option, the mower will travel along the wire to the Sub Zone on its own. When it is at least 5 m (16 ft) inside the Sub Zone, press STOP and select the area size of the Sub Zone. After finishing the process, the mower will drive back to the Base Station.

F. Finish Installing the Perimeter Wire

Insert the remaining pegs along the Perimeter Wire, approx. 1 m (3.3 ft) apart.

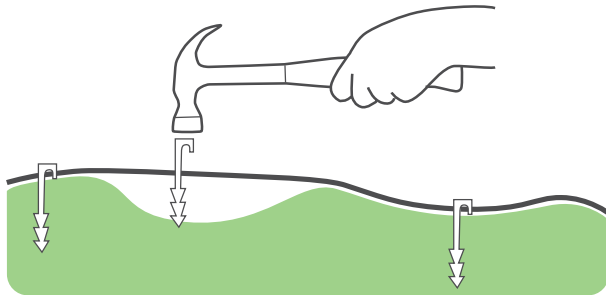

Hammer the extension cable into the ground so it's not a tripping hazard.

G. Charge your mower

Place your mower on the Base Station and let it fully charge before its first mow (up to 24 hours). Once it is fully charged, it will depart automatically according to its mowing schedule.

Caution

- The Safety Switch should be set to 'On' during charging
- Don't touch the blades
- Never mow when people, especially children or pets, are nearby.
- Make sure the lawn is clear of debris. The limited warranty of your mower does not cover damages caused by objects left in the lawn.



Don't worry if your lawn looks patchy for the first few days. It will even out after the first few mows!



TIP

A. Are there any Separated Zones?

For lawns that have completely noncontiguous Separated Zones, the area of these zones needs to be programmed separately.

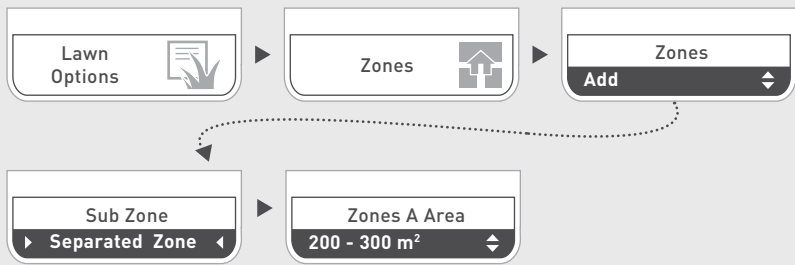

B. Splicing the Perimeter Wire (as needed)

- Insert both wire ends into the leftmost and rightmost positions on the connector.
- Verify that the wires are fully inserted into the connector.
- Use a pair of pliers to press the button on top of the connector. The button should be fully pressed, without damaging the connector.

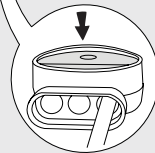
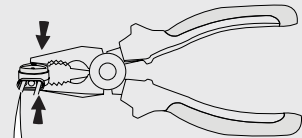
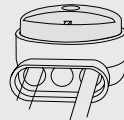

A helpful video is available online

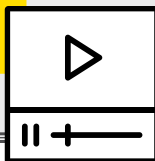

Well Done!

***Now relax, and let your
mower do the work.***

- ①** *Knowing your mower*
- ②** *Menu structure*
- ③** *Automatic operation*
- ④** *Manual operation*
- ⑤** *Features - how to*
- ⑥** *Periodic maintenance*
- ⑦** *Troubleshooting*
- ⑧** *FAQs*

1 **Knowing your mower**

In order to fully enjoy your mower, learn about its different parts and messages. Understanding how it works and “interacts” will lead to its smooth and easy operation.

External Parts

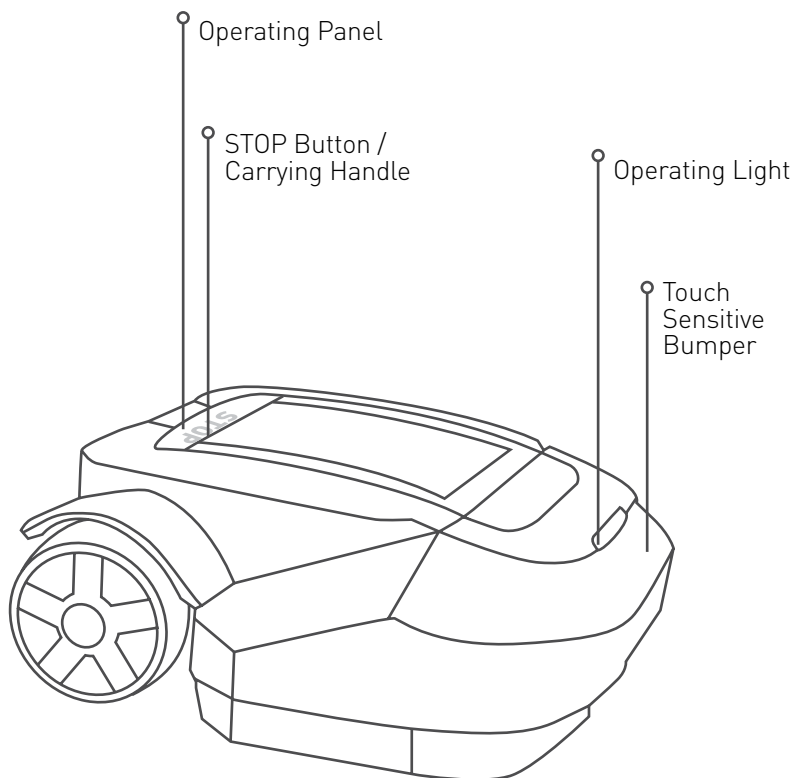

Under the Hood Parts

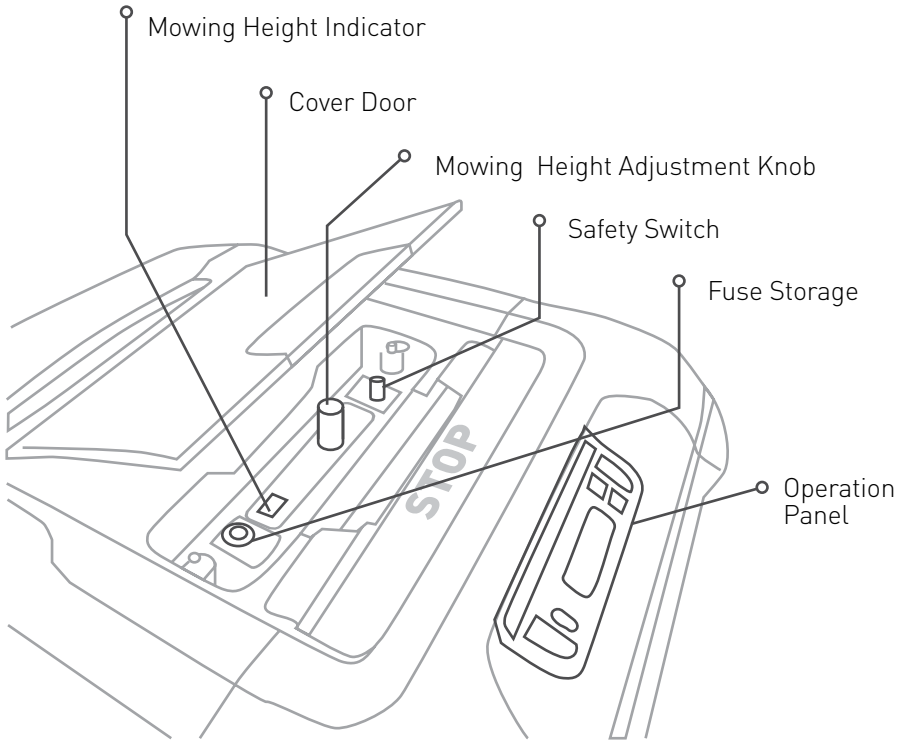

Operation Panel

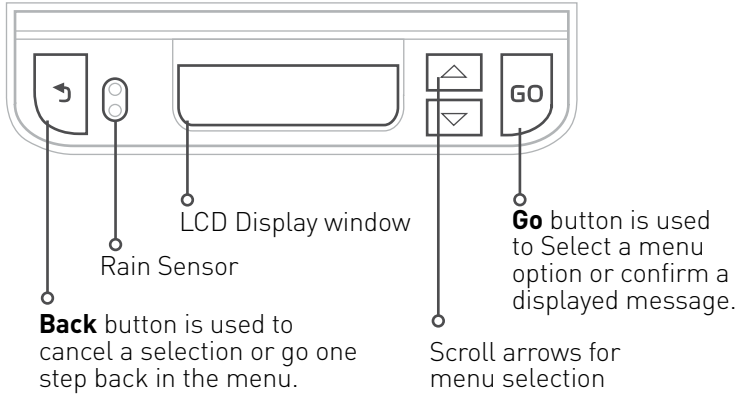

LCD display

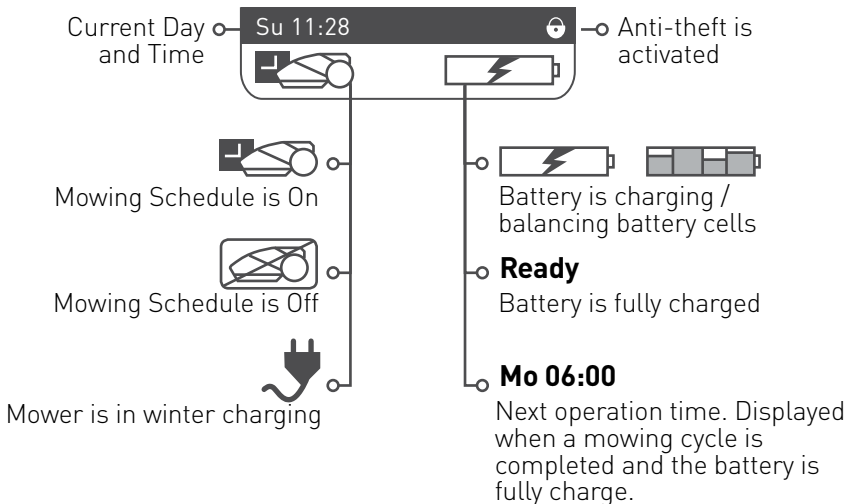

Base Station LED indication

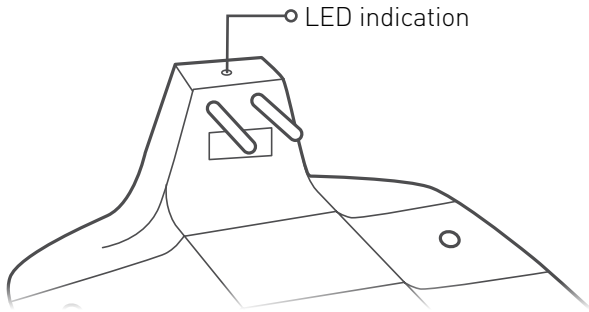

Indication	Meaning
Steady green	Perimeter wire signal is OK; the mower is inside the base
Blinking green	Perimeter wire signal is OK; the mower is outside the base
Blinking red fast	Perimeter wire is damaged or disconnected
Blinking red slow	Poor perimeter wire connection or the wire is too long
Steady red	Faulty power supply

2 Menu structure





For a full description of all menu items, please refer to our online Help Center.

Navigate the menus by using the **arrows** and make a selection by pressing **Go**.



Lawn Options

Configure lawn and mowing parameters

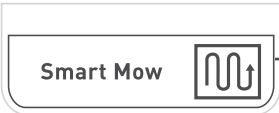
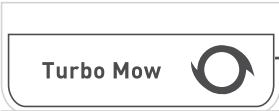
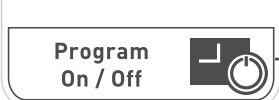
-  **Inactive Time**
Set mowing-free times
-  **Mowing Extent**
Set how often to mow your lawn
-  **Zones**
Add, remove or edit zones
-  **Islands**
Switch Islands feature on/off
-  **Near Wire Follow**
Reduce wheel tracks along lawn's edge
-  **Smart Mow**
Increase mowing efficiency
-  **Turbo Mow**
Enable faster and stronger cut (use for first cut of the season)
-  **Program On/Off**
Enable/Disable automatic operation by zone



Mower Options

Configure user preferences



Child Lock

Lock the keypad to prevent accidental press



Anti - Theft

PIN Code protection and alarm in case of theft

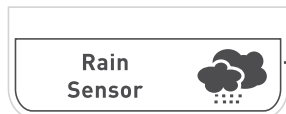

Rain Sensor

Automatically halt operation in rain/humid weather



RoboHome

RoboHome accessory on/off

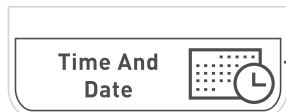

Time and Date

Set date & time



Energy Saver

Minimize power consumption and disable automatic operation to comply with CEC/DoE regulation. Appears only when Program is set to Off.

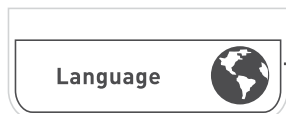

Language

Change mower's menu language

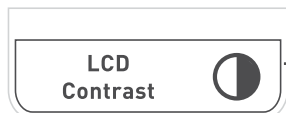

LCD Contrast

Adjust the LCD's contrast

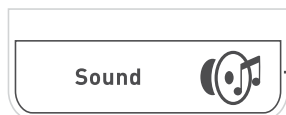

Sound

Turn Sound on/off

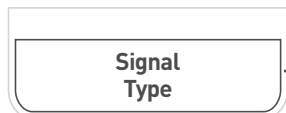

Signal Type

Change it to avoid interference with other robotic mowers around

3

Automatic operation

Learn how to configure automatic operation and manually bypass/override it when needed

- The Area size setting automatically determines the required mowing time for your lawn - the duration of a “Mowing Cycle”
- The mower usually performs several consecutive mowing operations until it completes a full Mowing Cycle
- Each mowing operation starts at predetermined times, once the mower is fully charged
- You can restrict automatic operation at particular times via the Inactive Time setting
- Once a Mowing Cycle is completed, the mower will stay in the Base Station until the next cycle begins
- The interval between mowing cycles is defined by the Mowing Frequency setting
- If required, extra mowing time can be added via the Mowing Hours setting to improve mowing results.

Tell your mower how often to mow

Mowing Frequency* controls the periodicity of mowing cycles. The higher the frequency, the more frequently your lawn will be mowed and vice versa.

Mowing frequencies:

Low - 1 Mowing Cycle per week

Medium - 2 Mowing Cycles per week

High - Lawn is mowed daily

*This option is only available for zones with a Base Station.

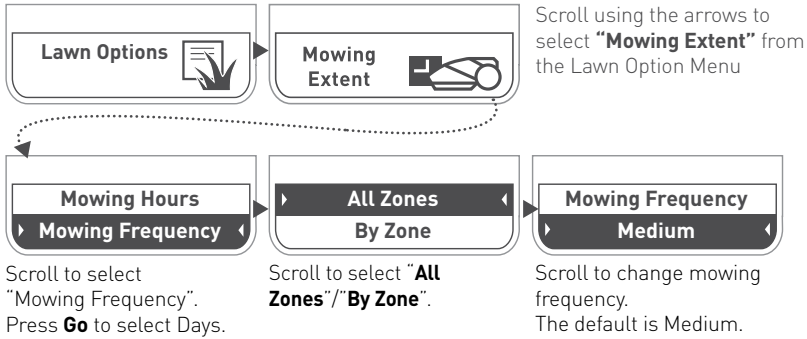

Decide when you need the lawn for yourself

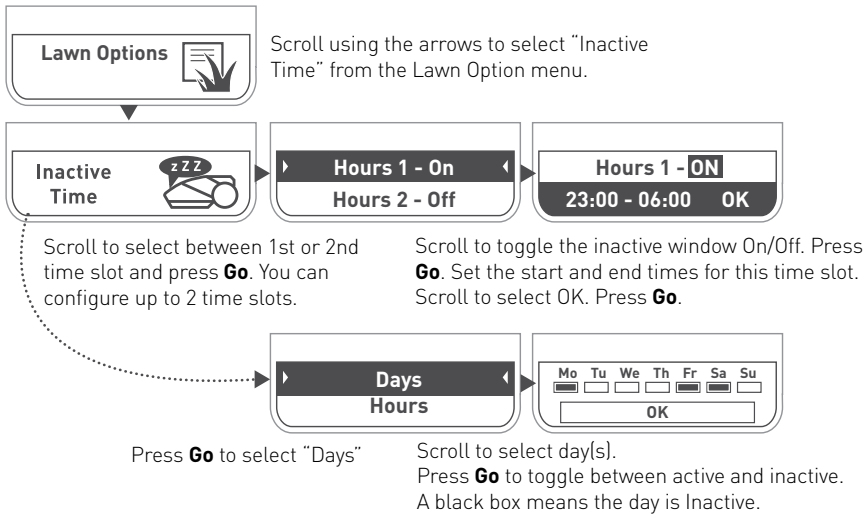

When setting inactive times, make sure to leave enough mowing time to your mower. If the available mowing time is too short for your lawn's size, the mower will notify you.



TIP

When you need extra mowing time

If the mowing results are not satisfactory, the 'Mowing Hours' option allows adjusting the duration of the mowing cycle allocated for your area setting (by percentage):

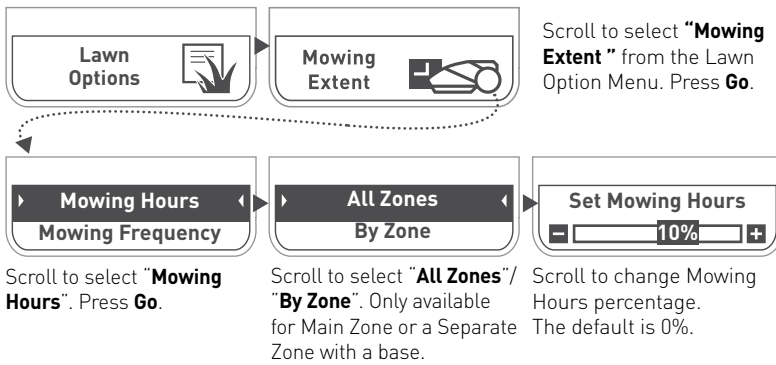

Pause automatic operation when needed

The automatic operation comes enabled by default. If you need to pause an automatic operation for any reason, you can do so by pressing STOP button for 5 seconds while the mower is inside the Base Station. To un-pause an automatic operation, repeat the process.

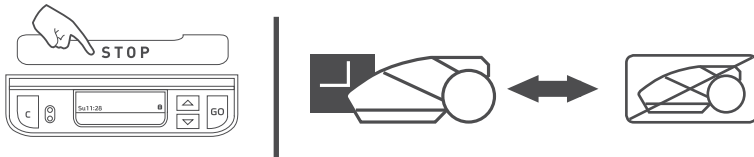

If you wish to pause an automatic operation in a particular zone, you can do so via the Program On/Off menu. When Program is set to Off in a particular zone, the mower will skip the operation in that zone, but will continue to mow the edge of the entire lawn anyway.

4 Manual operation

Manual Operation is used when you want to start a mowing operation, regardless of the mowing schedule.

Manual Operation with or without edging

To initiate Manual Operation:



Scroll to the zone you want the mower to mow.
Press **Go**.

Scroll to the operation mode (Edge+Mow or Mow Only).
Press **Go**.

5 Features - how to

Adjusting the mowing height

- Lift the Bumper Door at the top of the mower.
- Set the mowing height by turning knob (A) while pushing it down. The cutting height is displayed to the left of knob (B)
- The mowing height's range is 20-80 mm (0.8-3 in)

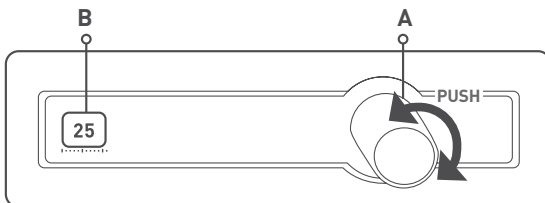

Child Lock

This feature is turned Off by default. To turn this feature on:

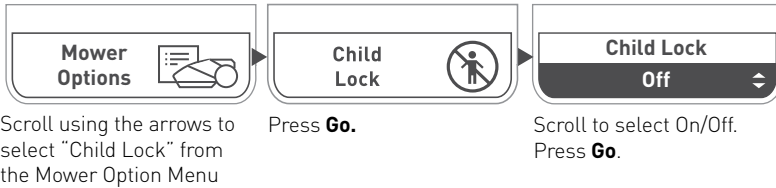

To temporarily release keys locked:

Press Up arrow, and then Back.

The keys will relock after 30 min. without user intervention.

Anti-Theft / Disabling Device feature

The Anti-Theft / Disabling Device prevents anyone from using or driving your mower unless they have a valid code to enter. In addition, it sets off an alarm in the event of unintended removal of the mower from its designated area. By default, this feature is turned Off. To turn it On for the first time:

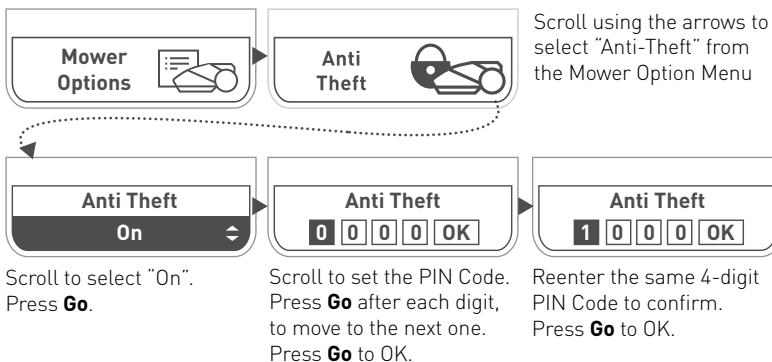

6

Periodic maintenance



WARNING

Severe injury and damage hazard!

Always turn the Safety Switch off before lifting the mower. Blades are very sharp. They can cause severe cuts or lacerations. Always wear heavy work gloves when working with or around the blades. NEVER use a damaged or broken blade. NEVER sharpen the blade manually.

Once a month:

- Inspect the underside of the mower. Clean if necessary. Carefully scrape the collected grass debris (using a small stick or similar object) from under the mowing deck.
- Check the Perimeter Wire and add pegs where it is loose and not tight to the ground. In case of seasonal changes in the lawn, make sure to adjust the wire accordingly.
- Inspect the Base Station, clean it from mud and debris to allow proper docking.



IMPORTANT!

NEVER use a high pressure water to clean the mower. Liquids can damage components. Use only a damp or wet cloth to wipe the surface clean after scraping.

Winter storage

The mower

- Charge the mower fully in its base
- Switch it off and remove the fuse
- Clean the mower and store it in dry indoor conditions at ambient temperatures above 0°C.

Base Station

- No winter storage is required for a Base Station. It can be left on the lawn during the winter period.
- It is recommended to disconnect the Power Supply from the mains during the winter storage period.

Winter service

- To allow better maintenance and to keep your mower in good condition, it is recommended to bring it to a certified dealer for service prior to winter storage.
- Winter service includes operations like cleaning the mower's parts and mowing deck, checking for worn parts (such as blades, drive wheels and other moving parts) and replacing them if required, testing the mower's functions and safety components, checking the battery, and uploading a latest software version, possibly including newly added features.

7

Troubleshooting

Message Displayed	Probable Cause / Event	Corrective Action
Cross Outside	The Perimeter Wire is too close to the edge.	Move the wire towards the inner side of the lawn.
	The lawn slope near the edge is too big and causes the mower to slip outside.	Do not include areas with very steep slopes.
	The lawn's edge is too bumpy.	Fill holes and pits along the edge till level with the ground.
Stuck In Place	The mower got stuck in place. It cannot continue driving.	Check the ground for holes or indentations. Fill it with some earth. Check if the Perimeter Wire is not too close to the edge. Move the wire towards the inner side of the lawn.
	Check Mow Height	Mowing system is in overload due to very tall grass or an obstacle that is stuck or wrapped around the blades.
Check Power		There is a temporary power cut.
	The Power Supply unit is not plugged in properly.	Confirm the Power Supply is plugged in.
	There is no charging source detected.	Clean the charging contacts on the Base Station and verify proper connection of the Base Station to the Power Supply unit.
No Wire Signal / Waiting for Signal	Power Supply unit is unplugged or there is a temporary power cut.	Make sure the Base Station is connected to the mains supply.
	Signal generator may need to be restarted.	Disconnect the Power Supply from the mains supply and reconnect after 10 seconds.
	The Perimeter Wire is not connected to the Base Station.	Check the connection of the Perimeter Wire to the Base Station.
	The Perimeter Wire is cut.	Check for cuts in the Perimeter Wire.

8

Frequently asked questions



Mower does not dock properly and sometimes misses Base Station's contacts

The entrance to the Base Station is not flat. Fill some ground to flatten the lawn around the Base Station to allow smooth entrance. Make sure the Perimeter Wire is straight and centered all the way under the Base Station.



The rain sensor stopped working

After a certain period of time in outdoor conditions the rain sensor's pins may become oxidized and thus less sensitive to rain. Try to scrubbing the pins with a rugged damp or scotch.



Poor quality of mowing

The blades may be dull. Switch off the Safety Switch and try swapping between blades or replacing them. Use heavy gloves when inspecting blades.

The grass may be wet. For the best cut, operate the mower when the grass is dry. It is recommended not to mow in the early morning hours.



Patchy and uneven mowing

Minimize Inactive Time to allow the mower to complete Mowing Cycle quicker. If it is the fast growing season - reduce the time between mowing cycles via the **Mowing Frequency** setting. Increase the allocated mowing time via the **Mowing Hours** setting to compensate for the lawn's shape complexity.



Mower does not depart from base for a long time

Press and hold the UP for 1 second while the mower is in the Base Station. The non-depart reason code will be displayed for 3 seconds. Refer to our online Help Center for a detailed description of non-depart codes.

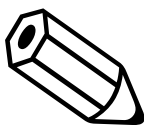

Contact
us!



WWW.ROBOMOW.COM

MTD Products Aktiengesellschaft Industriestraße 23 • 66129 Saarbrücken • Germany



DOC6011G_EN

robomow.com f